

Abu Tbeirah Excavations I. Area 1

Last Phase and Building A – Phase 1

edited by
Licia Romano and Franco D'Agostino



Collana Materiali e documenti 44

Abu Tbeirah
Excavations I. Area 1
Last Phase and Building A – Phase 1

edited by
Licia Romano and Franco D'Agostino



SAPIENZA
UNIVERSITÀ EDITRICE
2019



STATE BOARD FOR ANTIQUITIES
& HERITAGE, IRAQ

Copyright © 2019

Sapienza Università Editrice
Piazzale Aldo Moro 5 – 00185 Roma

www.editricesapienza.it
editrice.sapienza@uniroma1.it

Iscrizione Registro Operatori Comunicazione n. 11420

ISBN 978-88-9377-108-5

DOI 10.13.133-9788893771085

Pubblicato giugno 2019



Quest'opera è distribuita
con licenza Creative Commons 3.0
diffusa in modalità *open access*.

*This book is dedicated to Amir Doshi,
whose friendship is the pillar
of our work at Abu Tbeirah*

Table of Contents

1. Foreword (F. D’Agostino - L. Romano)	1	5.3 Results	54
1.1 Registering Systems	5	5.3.1 Archaeological Sites	54
1.2 Acknowledgments	5	5.3.2 Palaeochannels	54
1.3 Members of the Excavation Campaigns at Abu Tbeirah	7	5.3.3 “Hollow Ways”	54
2. Let’s Dig It! The Story of Abu Tbeirah in the Vicinity of Ur (A. Hamdani)	9	5.3.4 Grooves	54
3. Geology and Palaeoenvironment of Nasiriyah Area/Southern Mesopotamia (S. Milli - L. Forti)	19	5.3.5 Crevasse Splays	54
3.1 Geomorphology	21	5.4 Conclusions	54
3.2 Geological Setting	23	References	57
3.3 The Quaternary Deposits	24	6. Abu Tbeirah and Area 1 in the Second Half of the 3 rd Mill. BC (L. Romano)	59
3.4 The Holocene Stratigraphy and Sedimentology of the Southern Mesopotamian Plain	26	6.1 Abu Tbeirah: Overview of the Site	61
3.5 Stratigraphy of the Nasiriyah Sector	31	6.1.1 Post-Depositional Alterations and Taphonomic Agents	64
References	33	6.2 Cemetery and Other Activities	66
4. Palaeoenvironment, Climate and Land Use in Southern Mesopotamia/Nasiriyah Area (A. Celant - D. Magri)	39	6.2.1 Cemetery or Sub-Pavimental Burials?	66
4.1 The Mesopotamian Palaeoenvironment	41	6.2.2 Abu Tbeirah’s Burial Practices	68
4.2 The 4.2 ka BP Event	43	6.2.3 Insights into the ED III - Akk. Funerary Practices	72
4.3 The Abu Tbeirah Plant Remains: Preliminary Insights	45	6.3 Building A	76
References	46	6.3.1 Building Techniques and Materials	77
5. The Environment and Landscape Archaeology of the Abu Tbeirah Region (J. Jotheri)	49	6.3.2 Plan, Circulation System and Natural Lighting	78
5.1 Introduction	51	6.3.3 Fire Installations and Artificial Illumination of the Building	79
5.2 Methodology	53	6.3.4 Sub-Pavement Graves	81
5.2.1 Remote Sensing	53	6.3.5 Dog (Ritual?) Deposition	82
5.2.2 Groundtruthing	53	6.3.6 Rooms Function(s) and Building A Household	83

6.4	Area 1: Towards an Abandonment Time-Line	84	8.2	Room 2	196
6.5	Future Perspectives	86	8.3	Room 3	205
	References	87	8.4	Room 4	206
7.	Area 1: Cemetery and Other Activities (L. Romano - A.K. Ghanim)	93	8.5	Room 5	214
7.1	Mc-fXIII1-4	95	8.6	Room 6	220
7.1.1	Other Activities	95	8.7	Room 7	222
7.1.2	Grave 1	109	8.8	Room 8	225
7.1.3	Grave 2	112	8.9	Room 9	231
7.1.4	Grave 3	114	8.1	Room 10	236
7.1.5	Grave 6	116	8.11	Room 11	238
7.1.6	Grave 11	122	8.12	Room 12	243
7.2	MdXIII5+6+MeXIII5	126	8.13	Room 13	245
7.2.1	Grave 15	126	8.14	Room 14-15	250
7.2.2	Grave 16	133	8.15	Room 16	258
7.2.3	Other Activities	141	8.16	Room 17+19+21	262
7.3	Mb-cXIII5	158	8.17	Room 18	266
7.3.1	Grave 22	158	8.18	Room 20	268
7.4	Mb-dXIII6-7	165	8.19	Room 22	269
7.4.1	Other Activities	165	8.20	Room 23	271
7.4.2	Grave 17	169	8.21	Building A North-Western Outside	277
7.4.3	MdXIII7	173	9.	Micro-Debris Analysis of Building A - Phase 1 Room 23 (S. Cereda)	311
7.5	MdXIII6+MeXIII5+6	174	9.1	Introduction	313
7.5.1	Other Activities	174	9.2	Use of Space and Microscopic Record	313
7.6	MfXIII3-5	179	9.3	Data Acquisition and Processing	314
7.6.1	Other Activities	179	9.4	Results of Micro-Debris Analysis	315
7.6.2	Grave 21	179	9.5	Discussion of Results and Interpretation of Room 23	318
7.6.3	Grave 23	181	9.6	Conclusions	320
7.7	Mg-hXIII5-4	182		References	322
7.7.1	Grave 24	182	10.	Area 1 Pottery - Part 1: A Preliminary Assessment on Typology, Technology and Use (L. Romano - M. Zingale)	323
8.	Building A - Phase 1 (L. Romano - T. al-Hosseini)	189	10.1	Introduction	325
8.1	Room 1	191	10.2	Methodology	326

10.3	Typology	327	12.2.1	Description of the Burials and Preliminary Osteological Information	393
10.3.1	Open Shapes	327	12.3	Sub Pavimental Graves of Building A - Phase 1	398
10.3.2	Closed Shapes	335	12.3.1	Description of the Burials	398
10.3.3	Miscellaneous Vessels	339	12.4	Preliminary Osteological Notes	401
10.3.4	List of Pottery Vessels Considered in the Envelopes	341	12.5	The Isotopic Investigation	402
10.4	Shaping and Manufacturing Process	342	12.5.1	Stable Carbon and Nitrogen Isotopes	402
10.4.1	Insights into the Production of the Main Pottery Shapes	342	12.5.2	Strontium Isotopes Ratio	404
10.4.2	Surface Treatments and Decorations	355	12.6	Concluding Remarks	404
10.5	Use and Re-Use	360		References	405
10.6	Conclusions	362	13.	Faunal Remains (F. Alhaique)	419
	References	365	13.0	General Introduction	421
11.	Area 1 Pottery - Part 2: Clay, Fabrics and Firing Technology (G. Festa - V. Forte - L. Romano)	371	13.1	Area 1 Cemetery and Latest Activities	421
11.1	Introduction	373	13.1.1	Introduction	421
11.2	Mesopotamian Clay Sources	373	13.1.2	Grave 1	422
11.3	Macroscopic Classification of Ceramic Pastes	375	13.1.3	Grave 2	422
11.3.1	Selected Fragments	376	13.1.4	Grave 3	422
11.4	Neutron Investigations: Results and Discussion	378	13.1.5	Grave 6	422
11.4.1	Neutron Diffraction	378	13.1.6	Grave 11	422
11.4.2	Neutron Resonance Capture Analysis	379	13.1.7	Grave 15	422
11.4.3	Classification of the Samples on the Basis of the ND and NRCA	379	13.1.8	Grave 16	422
11.4.4	Autoptic V/S Neutron Classification	382	13.1.9	Grave 17	423
11.5	Insights into the Clay Selection and Firing Process	383	13.1.10	Grave 21	423
	References	385	13.1.11	Grave 22	423
12.	The Human Remains (M.A. Tafuri)	389	13.1.14	Grave 25	424
12.1	Introduction	391	13.1.15	Pit Under Graves 15 and 16 (MdXIII5+6+MeXIII5)	424
12.2	Area 1 Cemetery	393	13.1.16	Mc-f XIII 1-4	425
			13.1.17	MdXIII6+MeXIII5+6	425
			13.1.18	Mb-dXIII6-7	426
			13.1.19	Discussion - Cemetery and Latest Activities	426
			13.2	Area 1 Building A - Phase 1	426

13.2.1	Introduction	426	14.3	Raw Materials	442
13.2.2	Room 1	428	14.3.1	Artifacts Patination	443
13.2.3	Room 2	429	14.3.2	Preliminary Data About Chert Petrography	444
13.2.4	Room 3	429	14.3.3	Chert Availability in Southern Mesopotamia	444
13.2.5	Room 4	429	14.4	Blade Production	445
13.2.6	Room 5	429	14.4.1	Knapping Technique	446
13.2.7	Room 6	430	14.4.2	Technical Blades	447
13.2.8	Room 7	430	14.5	Sickle Production	447
13.2.9	Room 8	430	14.5.1	Retouch	447
13.2.10	Room 9	430	14.5.2	The Sickle Fragment from Building A - Room 23	448
13.2.11	Room 10	430	14.6	Conclusions	450
13.2.12	Room 11	430		References	451
13.2.13	Room 12	431	15.	Chipped Stone Artifacts: Use Wear Analysis (D. D'Errico)	455
13.2.14	Room 13	431	15.1	Introduction	457
13.2.15	Room 14 and Room 15	431	15.2	Results from Building A - Phase 1 Chert Tools	458
13.2.16	Room 16	432	15.3	The Sickle Elements of the Bitumen Handle AbT.15.114 (Building A - Phase 1 - Room 23)	459
13.2.17	Rooms 17+19+21	432	15.4	Conclusions	460
13.2.18	Room 18	432		References	462
13.2.19	Room 20	432	16.	Abu Tbeirah: A Philological and Epigraphic Point of View (F. D'Agostino - A. Greco)	463
13.2.20	Room 22	432	16.1	Premise	465
13.2.21	Room 23	433	16.2	The Water System of Abu Tbeirah	465
13.2.22	Outside Building A North-Western Side	433	16.3	Literary Compositions Describing Routes in the Proximity of Ur	467
13.2.23	Discussion - Building A - Phase 1	434	16.4	Cities in the Vicinity of Ur	468
13.3	Conclusion - Faunal Remains from Area 1	435	16.4.1	Enegir	469
	References	437	16.4.2	Kiabrig	470
14.	Chipped Stone Artifacts: Technological Analysis (D. Moscone)	439			
14.1	Introduction	441			
14.2	Composition of the Lithic Assemblage	441			

16.4.3	Ĝešbanda	471
16.4.4	Ga'eš	472
16.4.5	Aššu/Eššu	473
16.5	Conclusions	473
	Appendix. Fragments of Tablets and Inscribed Bricks from AbT	474
	References	476

CHAPTER 7

AREA 1: CEMETERY AND OTHER ACTIVITIES



CHAPTER 7

AREA 1: CEMETERY AND OTHER ACTIVITIES

Licia Romano
Sapienza University of Rome
Department “Institute of Oriental Studies”
licia.romano@uniroma1.it

Ali Ghanim Kadhem
Director of Ur Archeological City and
Supervisor of Foreign Archaeological
Missions in Thi Qar Province
Iraqi State Board of Antiquities and Heritage

7.1 Mc-fXIII1-4 [LR]¹

7.1.1 OTHER ACTIVITIES [LR]

Several modern activities connected to the recent presence of a temporary encampment were identified in squares Mc-fXIII1-3 (Fig. 7.1). The recent use of this part of the Tell hardened the soil and eased the accumulation of salt, evening out the surface: consequently, the satellite imagery did not show the underlying structures clearly. Lacking the experience and subsequent knowledge of Abu Tbeirah soil, during the first year one of these soil transformations was documented in detail: US 1 (elevation -0.016 m), the first identified “activity”, was not, indeed, a real stratum but the result of the passage of a vehicle. The soil was hardened by the passage of the wheels and appeared clearer in colour.² Both modern and ancient activities in squares Mc-fXIII1-3 were realized over US 4, a brown silt-clay soil that covered all the area.

In MeXIII1-2 (Fig. 7.1), south of Grave 2, a circular pit US 16-17, with vertical walls and a diameter of 0.8 m, was cut at the elevation of 0.1 m: the excavation reached a depth of -0.7 m but not the bottom of the pit. The pit was filled by fine sand, with very few inclusions. In the same squares

three hearts were discovered at the elevation of -0.12 m (US 22 - Figs 7.1 and 3). Their edges were hardened by use and, though the fireplaces were probably in connection with the Cemetery (or at least with the 3rd mill. BC activities),³ the extremely bad state of preservation of the sampled charcoal did not allow to recover a good amount of organic residue to proceed with AMS ¹⁴C dating.

In MdXIII1 (Fig. 7.1) a shallow pit (US 2-3), filled by a hazel-brown, quite soft and silty soil, contained fragments of pottery and part of a grindstone. The pit was quite shallow, cut from the elevation of -0.13 m and reaching the depth of -0.25 m.

Four small pits were recognized in MeXIII3 (Fig. 7.2). US 59-70 was cut at 0.08 m of elevation and reached a depth of -0.22 m. It was filled by an olive brown, silty-sandy and quite soft soil. Fragments of a very well-preserved modern rope and some reeds were discovered in the pit. The filling also includes fragments of mud-bricks belonging to the wall cut by US 70. US 72+73 was a small deep circular pit cut at -0.05 m and ending at the elevation of -0.5 m. It was filled by a light olive quite soft silty soil. US 75+76 was a bigger circular pit cut at the same elevation of the previous one but less deep (elevation of the bottom -0.2 m). It was filled by a light yellowish brown silty soil with sandy lenses.

¹ § 7 is written by L. Romano. We acknowledge the fundamental help of Ali Ghanim Khadem in the excavation of Abu Tbeirah. In the catalogue of the finds of each context the abbreviation “[SC]” indicates that the description was written by Stefano Caruso. The references quoted in the text are reported at the end of § 6. See §§ 12-13 for the detailed analyses and description of the human and faunal remains.

² See § 6.1.1 for post-depositional transformation at Abu Tbeirah.

³ D’Agostino *et al.* 2011: 28.

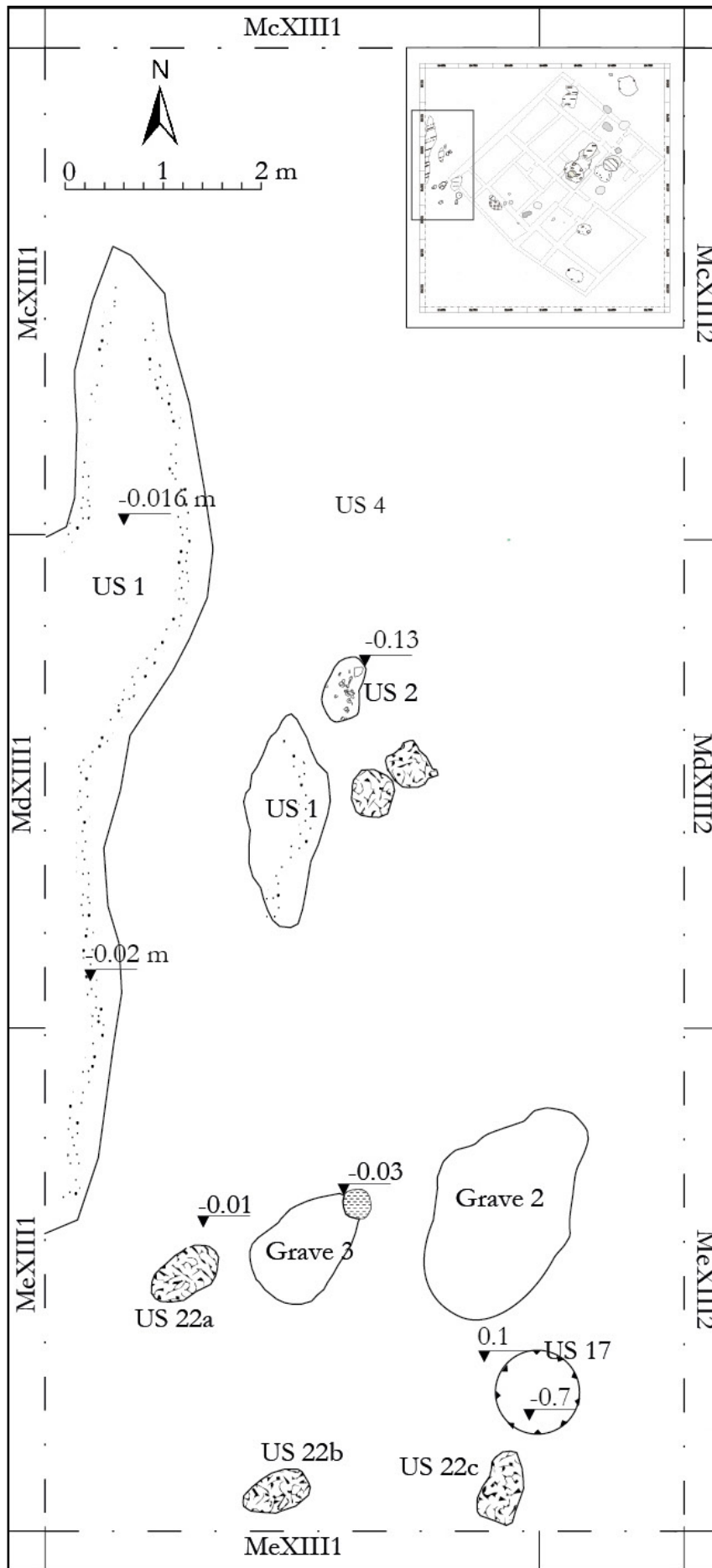

Fig. 7.1 Plan of the activities in Mc-eXIII1+2.

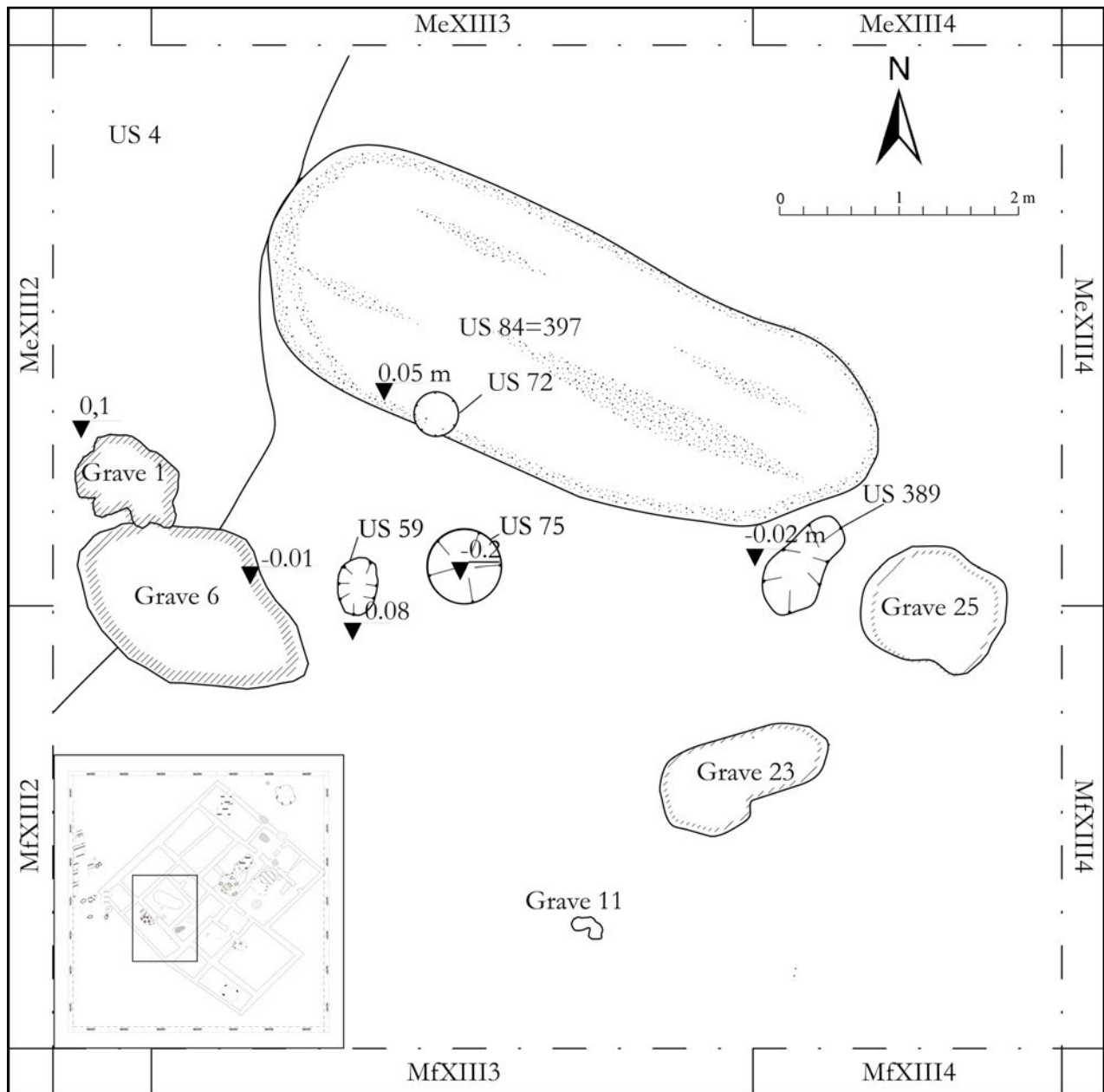

Fig. 7.2 Plan of the activities in Me-fXIII2-4.

US 388-389 was a shallow modern hole, cut at -0.02 m reaching a depth of -0.13 m.

A huge pit (US 84=397; cut US 101=398)⁴ cut the filling and the ground surface of Room 2 (US 77=400). The stratigraphic relations were confirmed during the 2015 campaign. The pit contained several different materials and it could be interpreted as possible dump pit.⁵



Fig. 7.3 Hearths (US 22).

⁴ The limits were already identified during the 2012 excavation.

⁵ At least 19 drinking vessels, 5 medium dimension jars and several fragments of coarse big vat (4 different kinds) were found.

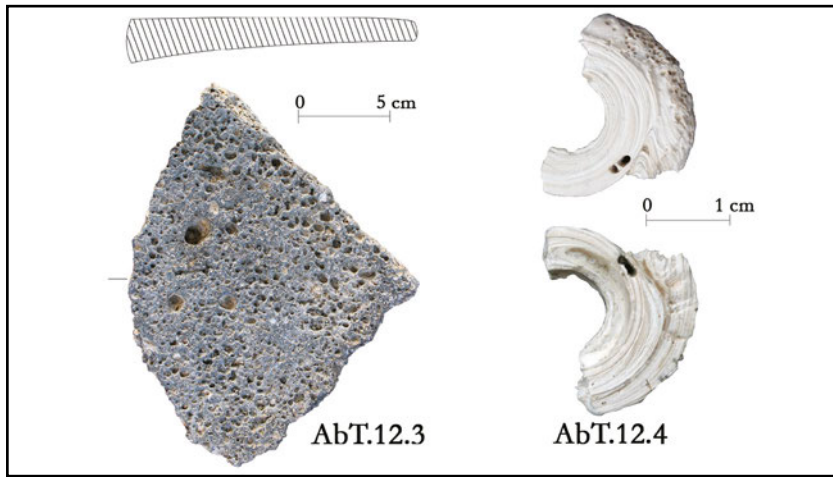

Fig. 7.4 US 2 objects.

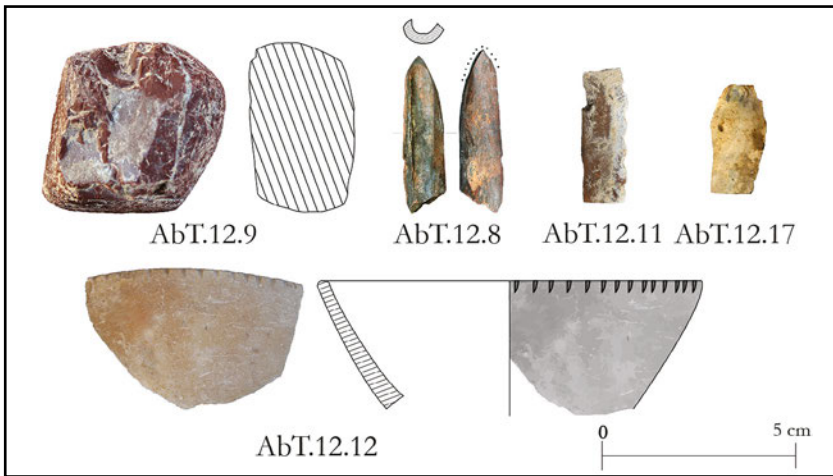

Fig. 7.5 US 4 objects.

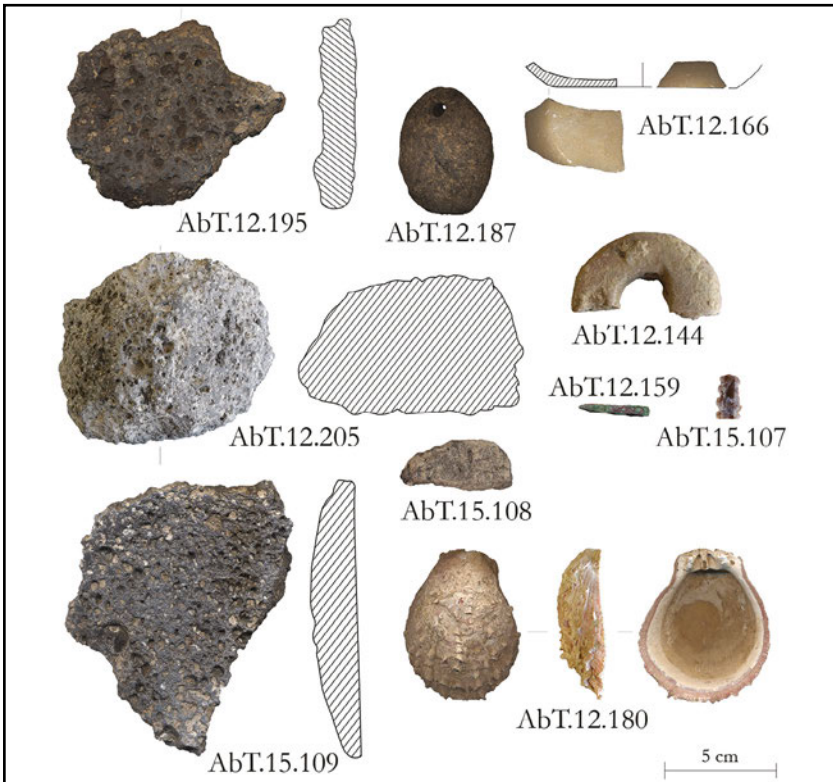

Fig. 7.6 US 84 objects.

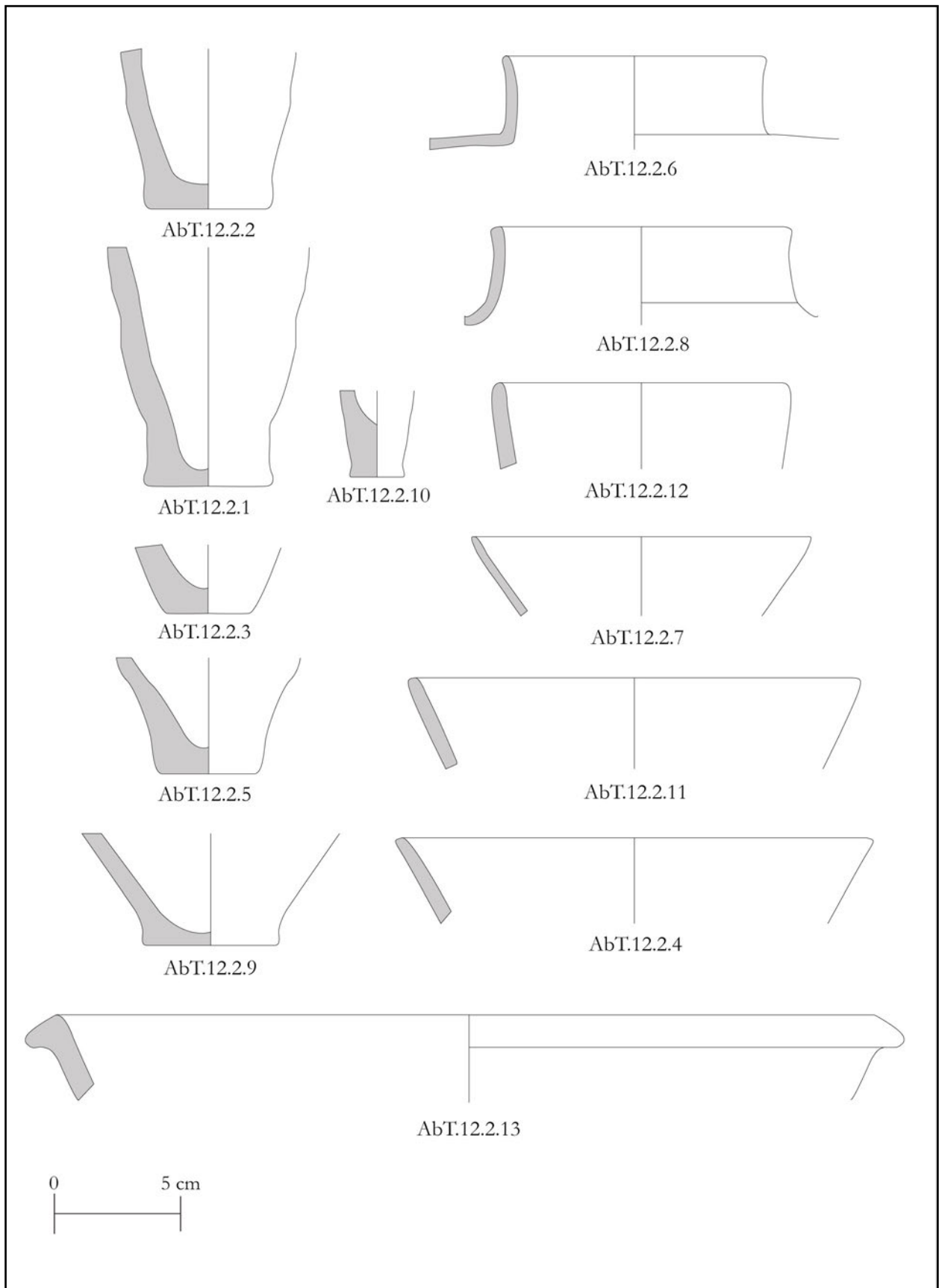

Fig. 7.7 US 2 pottery.

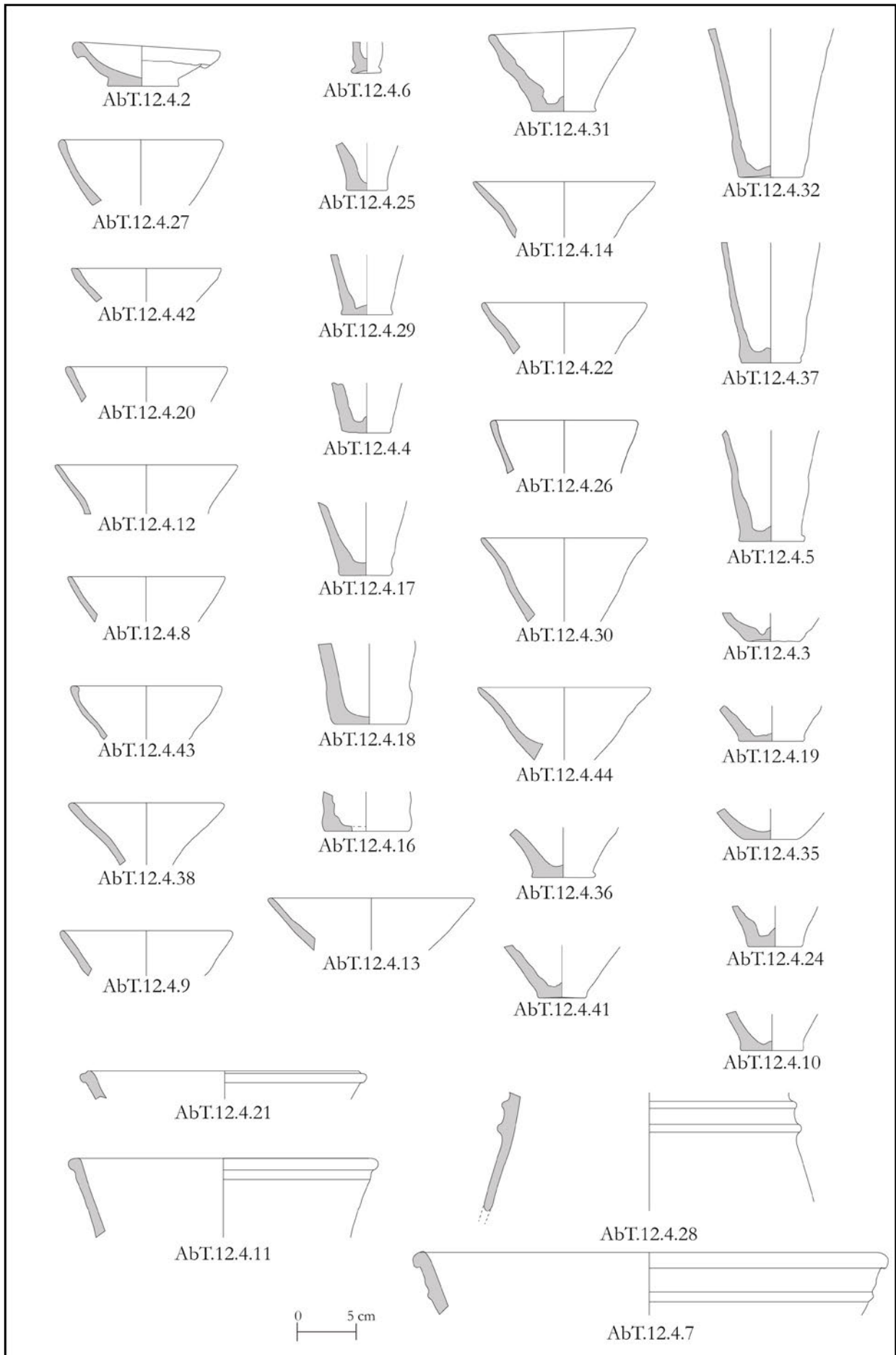

Fig. 7.8 US 4 pottery: open shapes.

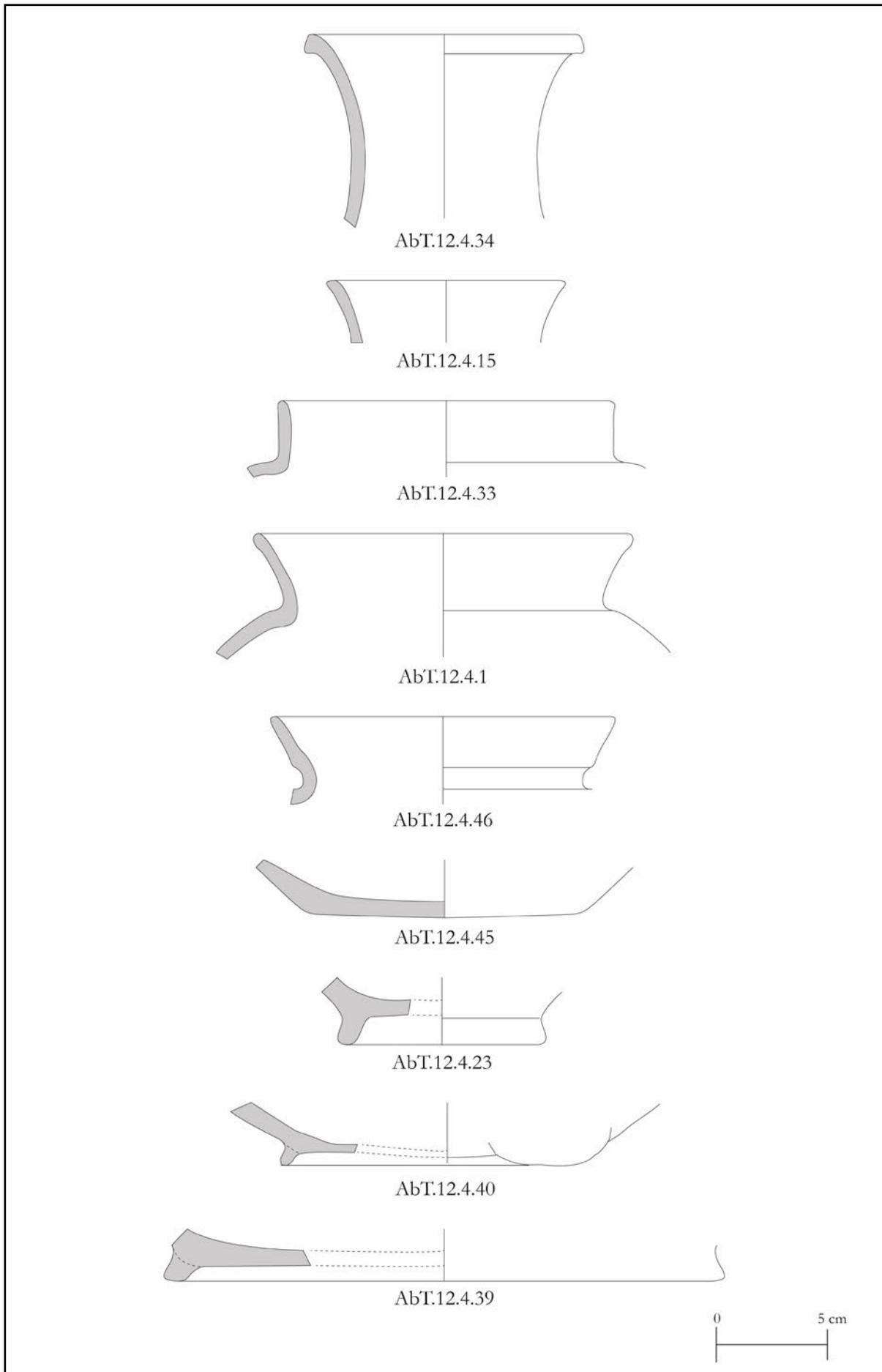

Fig. 7.9 US 4 pottery: closed shapes.

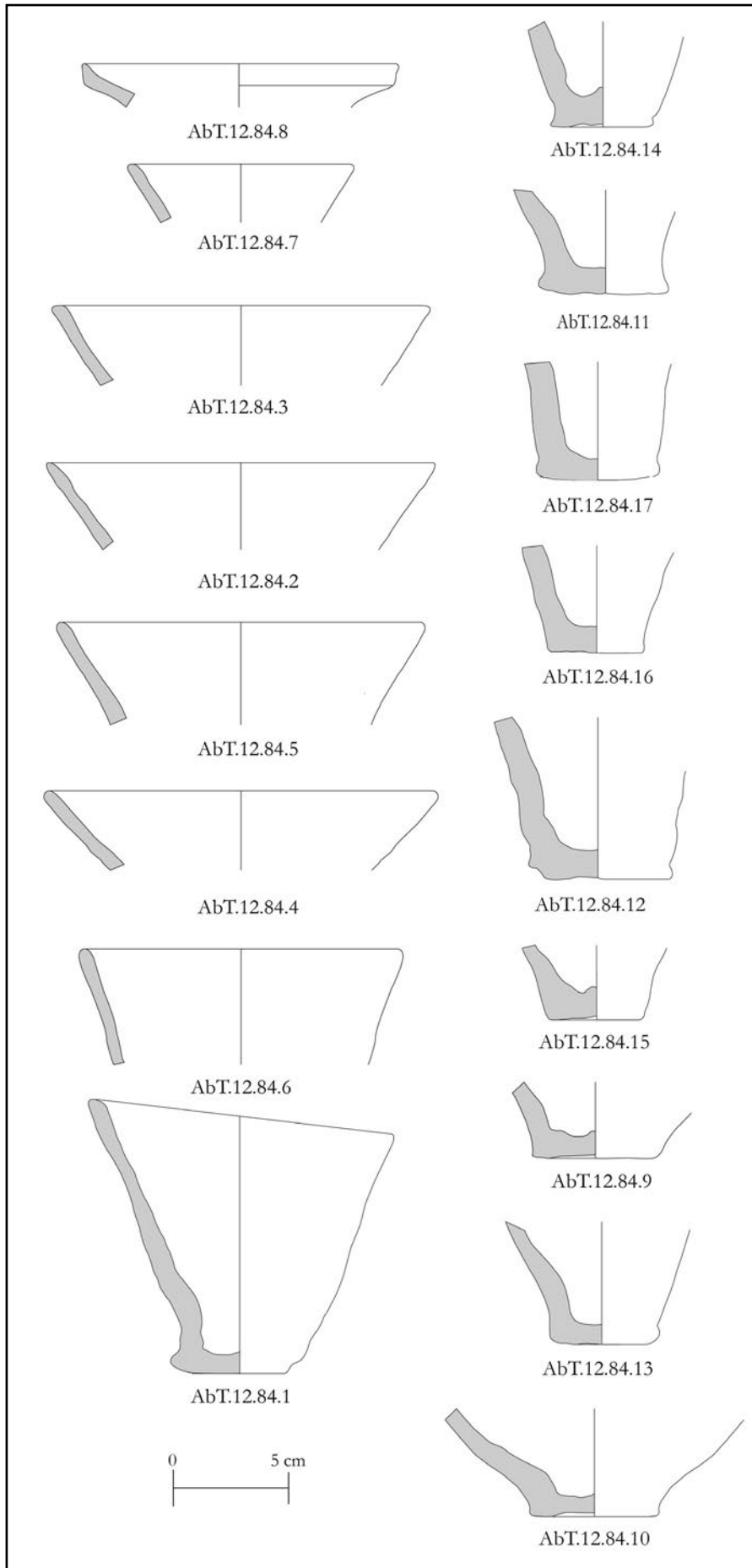

Fig. 7.10 US 84 pottery: open shapes.

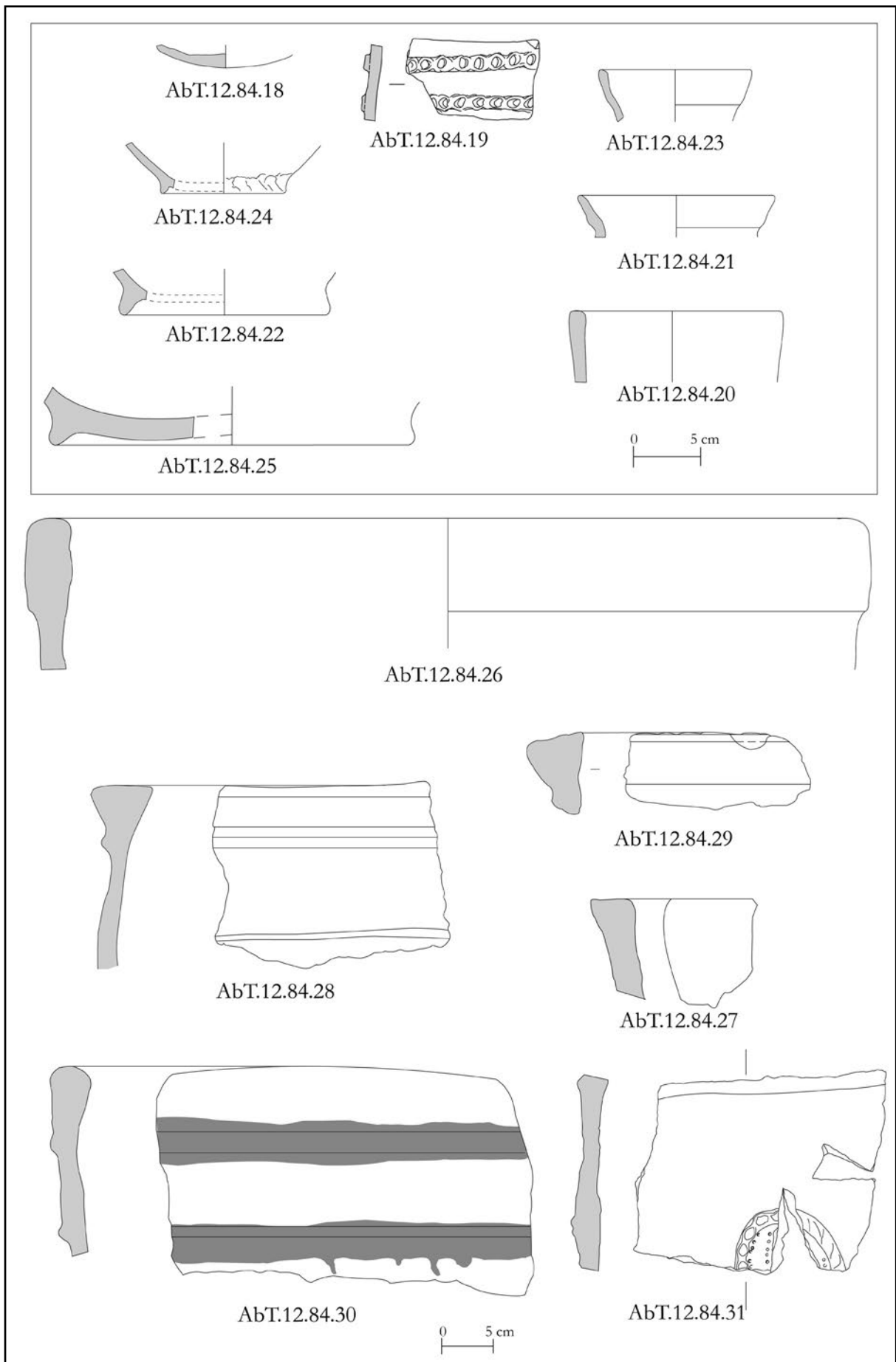

Fig. 7.11 US 84 pottery: closed shapes.

Catalogue of US 2 Finds

*Objects***AbT.12.3 - Fig. 7.4**

Description: fragment of a basalt grindstone.

Dimensions: 19.5x14.5x2 cm.

AbT.12.4 - Fig. 7.4

Description: broken circular shell ornament with central half preserved hole and two small through holes.

Dimensions: 2.3x1x0.4 cm.

*Pottery***AbT.12.2.1 - Fig. 7.7**

Dimensions: wall th.: 0.9 cm; base diam.: 5 cm; base th.: 0.5 cm.

Clay: outer and inner colour: 2.5Y 8/4 (pale brown); fabric colour: 2.5YR 5/4 (reddish brown); sand inclusions; medium-low firing temperature.

Description: beaker base.

AbT.12.2.2 - Fig. 7.7

Dimensions: wall th.: 0.8 cm; base diam.: 5 cm; base th.: 1 cm.

Clay: outer, inner and fabric colour: 2.5Y 7/4 (pale brown); sand inclusions; medium-high firing temperature.

Description: beaker base.

AbT.12.2.3 - Fig. 7.7

Dimensions: wall th.: 1.1 cm; base diam.: 3.5 cm; base th.: 1 cm.

Clay: outer, inner and fabric colour: 5YR 5/6 (yellowish red); sand inclusions; medium-low firing temperature.

Description: drinking vessel base.

AbT.12.2.4 - Fig. 7.7

Dimensions: rim diam.: 18 cm; rim th.: 0.4 cm; wall th.: 0.6 cm.

Clay: outer, inner and fabric colour: 5YR 7/6 (reddish yellow); sand inclusions; medium-low firing temperature.

Description: drinking vessel plain rim.

AbT.12.2.5 - Fig. 7.7

Dimensions: wall th.: 0.6 cm; base diam.: 4 cm; base th.: 1 cm.

Clay: outer, inner and fabric colour: 10YR 8/3 (very pale brown); sand inclusions; medium firing temperature.

Description: conical bowl base.

AbT.12.2.6 - Fig. 7.7

Dimensions: rim diam.: 10 cm; rim th.:

0.3 cm; wall th.: 0.4 cm.

Clay: outer, inner and fabric colour: 2.5Y 8/4 (pale brown); sand inclusions; medium firing temperature.

Description: plain rim jar.

AbT.12.2.7 - Fig. 7.7

Dimensions: rim diam.: 13 cm; rim th.: 0.3 cm; wall th.: 0.3 cm.

Clay: outer, inner and fabric colour: 10YR 8/3 (very pale brown); sand inclusions; medium firing temperature.

Description: drinking vessel rim.

AbT.12.2.8 - Fig. 7.7

Dimensions: rim diam.: 11 cm; rim th.: 0.5 cm; wall th.: 0.5 cm.

Clay: outer, inner and fabric colour: 2.5Y 8/4 (pale brown); sand inclusions; medium firing temperature.

Description: plain rim jar.

AbT.12.2.9 - Fig. 7.7

Dimensions: wall th.: 0.7 cm; base diam.: 5 cm; base th.: 0.5 cm.

Clay: outer, inner and fabric colour: 2.5YR 5/4 (reddish brown); sand inclusions; medium firing temperature.

Description: conical bowl base.

AbT.12.2.10 - Fig. 7.7

Dimensions: wall th.: 0.4 cm; base diam.: 2.4 cm; base th.: 2.1 cm.

Clay: outer, inner and fabric colour: 2.5Y 5/2 (greyish brown); sand inclusions; medium-high firing temperature.

Description: minaturistic beaker base.

AbT.12.2.11 - Fig. 7.7

Dimensions: rim diam.: 17 cm; rim th.: 0.5 cm; wall th.: 0.5 cm.

Clay: outer and inner colour: 2.5Y 8/2 (pale brown); fabric colour: 2.5YR 6/4 (light reddish brown); sand inclusions; medium-high firing temperature.

Description: drinking vessel rim.

AbT.12.2.12 - Fig. 7.7

Dimensions: rim diam.: 11 cm; rim th.: 0.6 cm; wall th.: 0.7 cm.

Clay: outer, inner and fabric colour: 2.5Y 8/2 (pale brown); sand inclusions; medium-high firing temperature.

Description: drinking vessel rim.

AbT.12.2.13 - Fig. 7.7

Dimensions: rim diam.: 32 cm; rim th.: 1.7 cm; wall th.: 0.8 cm.

Clay: outer, inner and fabric colour:

5YR 6/4 (light reddish brown); sand inclusions; medium firing temperature.

Description: triangular rim bowl.

Catalogue of US 4 Finds

*Objects***AbT.12.8 - Fig. 7.5**

Description: broken bone awl.

Dimensions: 4.2x0.3 cm.

AbT.12.9 - Fig. 7.5

Description: fragment of a red-stone cube.

Dimensions: 3x1x3.9 cm.

AbT.12.11 - Fig. 7.5

Description: chert sickle blade.

Dimensions: 1.2x3.2 cm.

AbT.12.12 - Fig. 7.5

Description: fragment of a calcite vessel with small triangular indentations on the rim.

Dimensions: 3.3x0.5x10 cm.

AbT.12.17 - Fig. 7.5

Description: chert blade.

Dimensions: 1.5x3x0.4 cm.

*Pottery***AbT.12.4.1 - Fig. 7.9**

Dimensions: rim diam.: 16.5 cm; rim th.: 0.5 cm; wall th.: 0.6 cm.

Clay: outer colour: 7.5YR 8/2 (pinkish white); inner and fabric colour: 7.5YR 6/6 (reddish yellow); sand inclusions; medium-low firing temperature.

Description: plain rim jar.

AbT.12.4.2 - Fig. 7.8

Dimensions: rim diam.: 13.2 cm; rim th.: 1.1 cm; wall th.: 9.4 cm; base diam.: 6.4 cm; base th.: 0.8 cm; h.: 3.5 cm.

Clay: outer colour: 2.5Y 8/4 (pale brown); inner and fabric colour: 2.5Y 5/4 (light olive brown); sand inclusions; medium-high firing temperature.

Description: conical bowl attached to a stand, used as mortar; rotation marks in the centre.

AbT.12.4.3 - Fig. 7.8

Dimensions: wall th.: 0.7 cm; base diam.: 5 cm; base th.: 1.2 cm.

Clay: outer, inner and fabric colour: 10YR 7/3 (very pale brown); sand

inclusions; medium firing temperature.
Description: conical bowl base.

AbT.12.4.4 - Fig. 7.8

Dimensions: wall th.: 1 cm; base diam.: 4 cm; base th.: 1.6 cm.

Clay: outer, inner and fabric colour: 10YR 8/4 (very pale brown); sand inclusions; medium-high firing temperature.

Description: beaker base.

AbT.12.4.5 - Fig. 7.8

Dimensions: wall th.: 0.5 cm; base diam.: 5.7 cm; base th.: 1.4 cm.

Clay: outer, inner and fabric colour: 2.5Y 7/4 (pale brown); sand inclusions; medium firing temperature.

Description: beaker base.

AbT.12.4.6 - Fig. 7.8

Dimensions: wall th.: 0.6 cm; base diam.: 2.5 cm; base th.: 1 cm.

Clay: outer, inner and fabric colour: 2.5Y 5/2 (greyish brown); sand inclusions; medium-high firing temperature.

Description: unclear miniaturistic base.

AbT.12.4.7 - Fig. 7.8

Dimensions: rim diam.: 41 cm; rim th.: 1.5 cm; wall th.: 1.1 cm.

Clay: outer, inner and fabric colour: 5YR 6/6 (reddish yellow); sand inclusions; medium-low firing temperature.

Description: triangular rim bowl or stemmed-dish base.

AbT.12.4.8 - Fig. 7.8

Dimensions: rim diam.: 14 cm; rim th.: 0.5 cm; wall th.: 0.6 cm.

Clay: outer, inner and fabric colour: 5YR 7/3 (pink); sand inclusions; medium-low firing temperature.

Description: drinking vessel rim.

AbT.12.4.9 - Fig. 7.8

Dimensions: rim diam.: 15 cm; rim th.: 0.5 cm; wall th.: 0.6 cm.

Clay: outer colour: 2.5Y 8/3 (pale brown); inner and fabric colour: 5YR 6/6 (reddish yellow); sand inclusions; medium-high firing temperature.

Description: drinking vessel rim.

AbT.12.4.10 - Fig. 7.8

Dimensions: wall th.: 0.7 cm; base diam.: 5.5 cm; base th.: 0.9 cm.

Clay: outer, inner and fabric colour: 5YR 5/8 (yellowish red); sand inclusions;

medium-low firing temperature.
Description: conical bowl base.

AbT.12.4.11 - Fig. 7.8

Dimensions: rim diam.: 26 cm; rim th.: 1.2 cm; wall th.: 0.8 cm.

Clay: outer, inner and fabric colour: 5YR 6/4 (light reddish brown); sand inclusions; medium-high firing temperature.

Description: triangular rim bowl or stemmed-dish base.

AbT.12.4.12 - Fig. 7.8

Dimensions: rim diam.: 16 cm; rim th.: 0.4 cm; wall th.: 0.5 cm.

Clay: outer, inner and fabric colour: 5YR 5/6 (yellowish red); sand inclusions; medium-low firing temperature.

Description: drinking vessel rim.

AbT.12.4.13 - Fig. 7.8

Dimensions: rim diam.: 18 cm; rim th.: 0.6 cm; wall th.: 0.9 cm.

Clay: outer colour: 2.5YR 5/6 (red); inner and fabric colour: 5YR 5/6 (yellowish red); sand inclusions; medium-low firing temperature.

Description: drinking vessel rim.

AbT.12.4.14 - Fig. 7.8

Dimensions: rim diam.: 16 cm; rim th.: 0.4 cm; wall th.: 0.7 cm.

Clay: outer, inner and fabric colour: 2.5YR 6/6 (light red); sand inclusions; medium-high firing temperature.

Description: drinking vessel rim.

AbT.12.4.15 - Fig. 7.9

Dimensions: rim diam.: 10 cm; rim th.: 0.5 cm; wall th.: 0.5 cm.

Clay: outer, inner and fabric colour: 2.5YR 7/8 (light red); sand inclusions; medium-low firing temperature.

Description: plain rim jar.

AbT.12.4.16 - Fig. 7.8

Dimensions: wall th.: 0.9 cm; base diam.: 7.5 cm; base th.: 0.5 cm.

Clay: outer, inner and fabric colour: 2.5Y 8/6 (yellow); sand inclusions; medium firing temperature.

Description: beaker base.

AbT.12.4.17 - Fig. 7.8

Dimensions: wall th.: 0.7 cm; base diam.: 4.5 cm; base th.: 1.2 cm.

Clay: outer, inner and fabric colour: 10YR 7/2 (light grey); sand inclusions;

medium-high firing temperature.
Description: beaker base.

AbT.12.4.18 - Fig. 7.8

Dimensions: wall th.: 1.1 cm; base diam.: 6.5 cm; base th.: 0.5 cm.

Clay: outer colour: 10YR 7/6 (yellow); inner and fabric colour: 10YR 6/4 (light yellowish brown); sand inclusions; medium firing temperature.

Description: beaker base.

AbT.12.4.19 - Fig. 7.8

Dimensions: wall th.: 0.7 cm; base diam.: 5.8 cm; base th.: 0.5 cm.

Clay: outer, inner and fabric colour: 5YR 6/8 (reddish yellow); sand inclusions; medium-low firing temperature.

Description: conical bowl base.

AbT.12.4.20 - Fig. 7.8

Dimensions: rim diam.: 14 cm; rim th.: 0.6 cm; wall th.: 0.6 cm.

Clay: outer, inner and fabric colour: 2.5Y 8/3 (pale brown); sand inclusions; medium firing temperature.

Description: drinking vessel rim.

AbT.12.4.21 - Fig. 7.8

Dimensions: rim diam.: 24 cm; rim th.: 1.2 cm; wall th.: 0.8 cm.

Clay: outer and inner colour: 5YR 6/4 (light reddish brown); fabric colour: 2.5Y 7/2 (light grey); sand inclusions; medium-low firing temperature.

Description: triangular rim bowl or stemmed-dish base.

AbT.12.4.22 - Fig. 7.8

Dimensions: rim diam.: 14.5 cm; rim th.: 0.5 cm; wall th.: 0.8 cm.

Clay: outer colour: 10YR 7/4 (very pale brown); inner and fabric colour: 10YR 6/3 (pale brown); sand inclusions; medium firing temperature.

Description: drinking vessel rim.

AbT.12.4.23 - Fig. 7.9

Dimensions: wall th.: 0.9 cm; base diam.: 8.7 cm; base th.: 0.7 cm.

Clay: outer colour: 2.5Y 8/2 (pale brown); inner and fabric colour: 7.5YR 5/6 (strong brown); sand inclusions; medium-low firing temperature.

Description: ring base.

AbT.12.4.24 - Fig. 7.8

Dimensions: wall th.: 0.5 cm; base diam.: 4.8 cm; base th.: 1.6 cm.

Clay: outer, inner and fabric colour:

7.5YR 6/6 (reddish yellow); sand inclusions; medium-low firing temperature.
Description: conical bowl base.

AbT.12.4.25 - Fig. 7.8

Dimensions: wall th.: 0.7 cm; base diam.: 3.7 cm; base th.: 0.7 cm.
Clay: outer, inner and fabric colour: 7.5YR 8/4 (pink); sand inclusions; medium-low firing temperature.
Description: beaker base.

AbT.12.4.26 - Fig. 7.8

Dimensions: rim diam.: 13 cm; rim th.: 0.6 cm; wall th.: 0.6 cm.
Clay: outer colour: 10YR 8/3 (very pale brown); inner and fabric colour: 7.5YR 6/4 (light brown); sand inclusions; medium-high firing temperature.
Description: drinking vessel rim.

AbT.12.4.27 - Fig. 7.8

Dimensions: rim diam.: 14.7 cm; rim th.: 0.7 cm; wall th.: 0.8 cm.
Clay: outer colour: 7.5YR 8/4 (pink); inner and fabric colour: 7.5YR 6/6 (reddish yellow); sand inclusions; medium-high firing temperature.
Description: drinking vessel rim.

AbT.12.4.28 - Fig. 7.8

Dimensions: wall th.: 0.7 cm.
Clay: outer colour: 10YR 8/2 (very pale brown); inner and fabric colour: 5YR 6/6 (reddish yellow); sand inclusions; medium-low firing temperature.
Description: part of a stemmed-dish base with two notched ridges.

AbT.12.4.29 - Fig. 7.8

Dimensions: wall th.: 0.4 cm; base diam.: 4.5 cm; base th.: 0.8 cm.
Clay: outer, inner and fabric colour: 5YR 8/3 (pink); sand inclusions; medium-low firing temperature.
Description: beaker base.

AbT.12.4.30 - Fig. 7.8

Dimensions: rim diam.: 14.9 cm; rim th.: 0.5 cm; wall th.: 0.8 cm.
Clay: outer, inner and fabric colour: 5YR 6/3 (light reddish brown); sand inclusions; medium-low firing temperature.
Description: drinking vessel rim.

AbT.12.4.31 - Fig. 7.8

Dimensions: rim diam.: 13 cm; rim th.: 0.7 cm; wall th.: 1.2 cm; base diam.: 5.7

cm; base th.: 1.4 cm; h.: 7.2 cm.
Clay: outer, inner and fabric colour: 10YR 6/3 (pale brown); sand inclusions; medium-high firing temperature.
Description: conical bowl.

AbT.12.4.32 - Fig. 7.8

Dimensions: wall th.: 0.6 cm; base diam.: 5.6 cm; base th.: 0.7 cm.
Clay: outer, inner and fabric colour: 5YR 5/6 (yellowish red); sand inclusions; medium-low firing temperature.
Description: beaker base.

AbT.12.4.33 - Fig. 7.9

Dimensions: rim diam.: 15 cm; rim th.: 0.5 cm; wall th.: 0.6 cm.
Clay: outer colour: 10YR 8/2 (very pale brown); inner and fabric colour: 5YR 4/6 (yellowish red); sand inclusions; medium-low firing temperature.
Description: plain rim jar.

AbT.12.4.34 - Fig. 7.9

Dimensions: rim diam.: 12 cm; rim th.: 0.9 cm; wall th.: 0.6 cm.
Clay: outer colour: 7.5YR 8/4 (pink); inner and fabric colour: 7.5YR 7/6 (reddish yellow); sand inclusions; medium-low firing temperature.
Description: triangular rim jar.

AbT.12.4.35 - Fig. 7.8

Dimensions: wall th.: 0.8 cm; base diam.: 5 cm; base th.: 0.9 cm.
Clay: outer, inner and fabric colour: 10YR 8/4 (very pale brown); sand inclusions; medium firing temperature.
Description: conical bowl base.

AbT.12.4.36 - Fig. 7.8

Dimensions: wall th.: 0.8 cm; base diam.: 5.3 cm; base th.: 1.2 cm.
Clay: outer, inner and fabric colour: 10YR 8/6 (yellow); sand inclusions; medium firing temperature.
Description: conical bowl base.

AbT.12.4.37 - Fig. 7.8

Dimensions: wall th.: 0.5 cm; base diam.: 5.3 cm; base th.: 1.3 cm.
Clay: outer, inner and fabric colour: 5YR 7/6 (reddish yellow); sand inclusions; medium-low firing temperature.
Description: beaker base.

AbT.12.4.38 - Fig. 7.8

Dimensions: rim diam.: 14 cm; rim th.: 0.7 cm; wall th.: 0.6 cm.
Clay: outer, inner and fabric colour:

10YR 8/4 (very pale brown); sand inclusions; medium firing temperature.
Description: drinking vessel rim.

AbT.12.4.39 - Fig. 7.9

Dimensions: wall th.: 1 cm; base diam.: 25 cm; base th.: 0.9 cm.
Clay: outer, inner and fabric colour: 10YR 8/4 (very pale brown); sand inclusions; medium firing temperature.
Description: ring base.

AbT.12.4.40 - Fig. 7.9

Dimensions: wall th.: 1 cm; base diam.: 15.2 cm; base th.: 0.5 cm.
Clay: outer colour: 10YR 8/2 (very pale brown); inner and fabric colour: 7.5YR 6/6 (reddish yellow); sand inclusions; medium-low firing temperature.
Description: jar base with three feet.

AbT.12.4.41 - Fig. 7.8

Dimensions: wall th.: 0.8 cm; base diam.: 4.2 cm; base th.: 1.5 cm.
Clay: outer, inner and fabric colour: 7.5YR 8/6 (reddish yellow); sand inclusions; medium-low firing temperature.
Description: conical bowl base.

AbT.12.4.42 - Fig. 7.8

Dimensions: rim diam.: 13 cm; rim th.: 0.7 cm; wall th.: 0.6 cm.
Clay: outer, inner and fabric colour: 5YR 7/6 (reddish yellow); sand inclusions; medium-low firing temperature.
Description: drinking vessel rim.

AbT.12.4.43 - Fig. 7.8

Dimensions: rim diam.: 13 cm; rim th.: 0.7 cm; wall th.: 0.4 cm.
Clay: outer, inner and fabric colour: 10YR 6/4 (light yellowish brown); sand inclusions; medium-low firing temperature.
Description: drinking vessel rim.

AbT.12.4.44 - Fig. 7.8

Dimensions: rim diam.: 15.4 cm; rim th.: 0.4 cm; wall th.: 1.6 cm.
Clay: outer, inner and fabric colour: 7.5YR 6/6 (reddish yellow); sand inclusions; medium-low firing temperature.
Description: drinking vessel rim.

AbT.12.4.45 - Fig. 7.9

Dimensions: wall th.: 0.5 cm; base diam.: 12 cm; base th.: 0.7 cm.
Clay: outer, inner and fabric colour:

10YR 8/4 (very pale brown); sand inclusions; medium firing temperature. Description: flat base.

AbT.12.4.46 - Fig. 7.9

Dimensions: rim diam.: 15 cm; rim th.: 0.5 cm; wall th.: 0.7 cm. Clay: outer, inner and fabric colour: 2.5Y 7/4 (pale brown); sand inclusions; medium firing temperature. Description: band rim jar.

Catalogue of US 84 Finds

Objects

AbT.12.144 - Fig. 7.6

Description: half of a clay loom weight. Dimensions: 6.67x3.57x2 cm.

AbT.12.159 - Fig. 7.6

Description: fragment of a copper alloy point. Dimensions: 3.2x0.7x0.67 cm.

AbT.12.166 - Fig. 7.6

Description: base fragment of a miniaturistic limestone vessel. Dimensions: 5.1x2.9x0.6 cm.

AbT.12.180 - Fig. 7.6

Description: shell. Dimensions: 5.8x7.1x1.8 cm.

AbT.12.187 - Fig. 7.6

Description: fragment of a bitumen object, probably a loom weight. Pierced on the top. Dimensions: 4.4x5.6x4.2 cm.

AbT.12.195 - Fig. 7.6

Description: basalt grindstone fragment. Dimensions: 9.7x8.5x1.8 cm.

AbT.12.205 - Fig. 7.6

Description: basalt grindstone fragment. Dimensions: 6.7x10x6.3 cm.

Pottery

AbT.12.84.1 - Fig. 7.10

Dimensions: rim diam.: 12.5 cm; rim th.: 0.65 cm; wall th.: 0.85 cm; base diam.: 5 cm; base th.: 0.6 cm; h.: 11.5 cm. Clay: outer and inner colour (self-slip): 5Y 7/3 (pale yellow); fabric colour: 10YR 6/3 (pale brown); sand inclusions; medium-low firing

temperature. Description: beaker.

AbT.12.84.2 - Fig. 7.10

Dimensions: rim diam.: 16 cm; rim th.: 0.6 cm; wall th.: 0.65 cm. Clay: outer, inner and fabric colour: 7.5YR 7/4 (pink); sand inclusions; medium firing temperature. Description: drinking vessel rim.

AbT.12.84.3 - Fig. 7.10

Dimensions: rim diam.: 15 cm; rim th.: 0.6 cm; wall th.: 0.6 cm. Clay: outer, inner and fabric colour: 7.5YR 7/4 (pink); sand inclusions; medium firing temperature. Description: drinking vessel rim.

AbT.12.84.4 - Fig. 7.10

Dimensions: rim diam.: 16 cm; rim th.: 0.65 cm; wall th.: 0.7 cm. Clay: outer, inner and fabric colour: 5YR 5/6 (yellowish red); sand inclusions; medium firing temperature. Description: drinking vessel rim.

AbT.12.84.5 - Fig. 7.10

Dimensions: rim diam.: 15 cm; rim th.: 0.6 cm; wall th.: 0.65 cm; base diam.: 5 cm; base th.: 1.2 cm; h.: 13.1 cm. Clay: outer, inner and fabric colour: 10YR 7/4 (very pale brown); sand inclusions; medium firing temperature. Description: drinking vessel rim.

AbT.12.84.6 - Fig. 7.10

Dimensions: rim diam.: 13 cm; rim th.: 0.7 cm; wall th.: 0.55 cm. Clay: outer, inner and fabric colour: 10YR 8/3 (very pale brown); sand inclusions; medium-high firing temperature. Description: drinking vessel rim.

AbT.12.84.7 - Fig. 7.10

Dimensions: rim diam.: 9 cm; rim th.: 0.6 cm; wall th.: 0.6 cm. Clay: outer, inner and fabric colour: 10YR 7/4 (very pale brown); sand inclusions; medium firing temperature. Description: drinking vessel rim.

AbT.12.84.8 - Fig. 7.10

Dimensions: rim diam.: 13 cm; rim th.: 0.4 cm; wall th.: 0.6 cm. Clay: outer, inner and fabric colour: 10YR 8/2 (very pale brown); sand inclusions; medium-high firing

temperature. Description: lid?

AbT.12.84.9 - Fig. 7.10

Dimensions: wall th.: 0.8 cm; base diam.: 5.5 cm; base th.: 1 cm. Clay: outer, inner and fabric colour: 7.5YR 7/4 (pink); sand inclusions; medium firing temperature. Description: conical bowl base.

AbT.12.84.10 - Fig. 7.10

Dimensions: wall th.: 0.7 cm; base diam.: 5 cm; base th.: 1.3 cm. Clay: outer, inner and fabric colour: 10YR 6/2 (light brownish grey); sand inclusions; medium-low firing temperature. Description: conical bowl base.

AbT.12.84.11 - Fig. 7.10

Dimensions: wall th.: 0.8 cm; base diam.: 5.5 cm; base th.: 1.1 cm. Clay: outer, inner and fabric colour: 2.5Y 6/3 (light yellowish brown); sand inclusions; medium firing temperature. Description: beaker base.

AbT.12.84.12 - Fig. 7.10

Dimensions: wall th.: 1.25 cm; base diam.: 5.5 cm; base th.: 1 cm. Clay: outer, inner and fabric colour: 2.5Y 7/4 (pale brown); sand inclusions; medium-low firing temperature. Description: beaker base.

AbT.12.84.13 - Fig. 7.10

Dimensions: wall th.: 0.9 cm; base diam.: 4.5 cm; base th.: 1.2 cm. Clay: outer, inner and fabric colour: 10YR 8/3 (very pale brown); sand inclusions; medium-high firing temperature. Description: beaker base.

AbT.12.84.14 - Fig. 7.10

Dimensions: wall th.: 0.95 cm; base diam.: 4.5 cm; base th.: 1.3 cm. Clay: outer, inner and fabric colour: 5YR 4/6 (yellowish red); sand inclusions; medium firing temperature. Description: beaker base.

AbT.12.84.15 - Fig. 7.10

Dimensions: wall th.: 0.8 cm; base diam.: 4 cm; base th.: 0.9 cm. Clay: outer, inner and fabric colour: 7.5YR 7/4 (pink); sand inclusions; medium firing temperature. Description: beaker base.

AbT.12.84.16 - Fig. 7.10

Dimensions: wall th.: 0.9 cm; base diam.: 4 cm; base th.: 1 cm.

Clay: outer, inner and fabric colour: 2.5Y 8/3 (pale brown); sand inclusions; medium firing temperature.

Description: beaker base.

AbT.12.84.17 - Fig. 7.10

Dimensions: wall th.: 1 cm; base diam.: 5 cm; base th.: 1.1 cm.

Clay: outer, inner and fabric colour: 7.5YR 7/4 (pink); sand inclusions; medium firing temperature.

Description: beaker base.

AbT.12.84.18 - Fig. 7.11

Dimensions: base diam.: 10 cm; base th.: 0.6 cm.

Clay: outer, inner and fabric colour: 5YR 7/6 (reddish yellow); sand inclusions; medium-high firing temperature.

Description: rounded base.

AbT.12.84.19 - Fig. 7.11

Dimensions: wall th.: 0.5 cm.

Clay: outer, inner and fabric colour: 2.5Y 8/2 (pale brown); sand inclusions; medium firing temperature.

Description: wall with applied notched ridges.

AbT.12.84.20 - Fig. 7.11

Dimensions: rim diam.: 16 cm; rim th.: 1.9 cm.

Clay: outer, inner and fabric colour: 2.5Y 7/3 (pale brown); sand inclusions; medium firing temperature.

Description: plain rim jar.

AbT.12.84.21 - Fig. 7.11

Dimensions: rim diam.: 14 cm; rim th.: 0.7 cm; wall th.: 0.7 cm.

Clay: outer, inner and fabric colour: 2.5Y 8/2 (pale brown); sand inclusions; medium-high firing temperature.

Description: band rim jar.

AbT.12.84.22 - Fig. 7.11

Dimensions: base diam.: 15 cm; base th.: 0.6 cm.

Clay: outer, inner and fabric colour: 2.5Y 8/2 (pale brown); sand inclusions; medium-high firing temperature.

Description: ring base.

AbT.12.84.23 - Fig. 7.11

Dimensions: rim diam.: 11 cm; rim th.: 0.9 cm.

Clay: outer, inner and fabric colour: 2.5Y 8/2 (pale brown); sand inclusions; medium-high firing temperature.

Description: band rim jar.

AbT.12.84.24 - Fig. 7.11

Dimensions: base diam.: 9 cm; base th.: 0.55 cm.

Clay: outer, inner and fabric colour: 2.5Y 8/3 (pale brown); sand inclusions; medium-high firing temperature.

Description: ring base.

AbT.12.84.25 - Fig. 7.11

Dimensions: base diam.: 13 cm; base th.: 0.7 cm.

Clay: outer, inner and fabric colour: 10YR 8/2 (very pale brown); sand inclusions; medium-high firing temperature.

Description: ring base.

AbT.12.84.26 - Fig. 7.11

Dimensions: rim diam.: 82.6 cm; rim th.: 2.8 cm; wall th.: 1.6 cm.

Clay: outer, inner and fabric colour: 5YR 6/4 (light reddish brown); sand and vegetal inclusions; low firing temperature.

Description: rim of a big jar (inclination not clear).

AbT.12.84.27 - Fig. 7.11

Dimensions: rim diam.: n.d.; rim th.: 2.5 cm.

Clay: outer, inner and fabric colour: 7.5YR 6/4 (light brown); sand and vegetal inclusions; medium-low firing temperature.

Description: rim of a big jar/vat.

AbT.12.84.28 - Fig. 7.11

Dimensions: rim diam.: nd.; rim th.: 5.45 cm; wall th.: 1.6 cm.

Clay: outer and inner colour: 10YR 7/3 (very pale brown); fabric colour: 7.5YR 3/1 (very dark grey); sand and vegetal inclusions; medium-low firing temperature.

Description: 9 fragments of a large vat with a triangular rim and a ridge under it.

AbT.12.84.29 - Fig. 7.11

Dimensions: rim diam.: n.d.; rim th.: 6.4 cm.

Clay: outer, inner and fabric colour: 10YR 7/3 (very pale brown); sand and vegetal inclusions; medium-low firing temperature.

Description: triangular rim of a large vat.

AbT.12.84.30 - Fig. 7.11

Dimensions: rim diam.: n.d.; rim th.: 4 cm.

Clay: outer, inner and fabric colour: 2.5Y 6/3 (light yellowish brown); sand and vegetal inclusions; medium-low firing temperature.

Description: large vat. Bitumen band under the rim between two ridges.

AbT.12.84.31 - Fig. 7.11

Dimensions: rim diam.: n.d.; rim th.: 3.2 cm; wall th.: 1.9 cm.

Clay: outer, inner and fabric colour: 5YR 7/4 (pink); sand and vegetal inclusions; medium-low firing temperature.

Description: large vat wall decorated with a curved notched ridge, enclosing two circular and almost concentric lines of impressed dots.

7.1.2 GRAVE 1 [LR]

Grave 1 (Figs 7.12-13 and 7.21) was located in the southern corner of MeXIII2, immediately under the surface.⁶ The body was inhumed in a shallow pit (US 7), the limits of which were unclear due to the condition of the soil, extremely wet during Winter 2012 (Fig. 7.12).⁷

The filling (US 5) was a hard dark-brown clay soil and covered an equipment (Fig. 7.12) made up by: a conical bowl near the head (AbT.12.5.3), two jars over the lower part of the body (AbT.12.5.1-2), and by a spouted white limestone vessel (AbT.12.5).

The skeleton of a child (US 6) was layed in semi-flexed position, with the head towards west and looking south, the legs bent toward south, the left arm bent and the right one over the hips. Probably the infant was wrapped up with a reed-mat, found mostly over the chest and near the head.

Though apparently in good conditions, the position of the grave immediately under the top soil left the bones in a bad state of preservation (in some cases only the impressions of the bones on the soil were left).



Fig. 7.12 Grave 1 during the excavation: detail of the jar discovered and probably belonging to Grave 6.



Fig. 7.13 Grave 1, skeleton US 6.

⁶ See D'Agostino *et al.* 2011: 27. The elevation is of -0.12 m (in D'Agostino *et al.* 2011: Fig. 10 a wrong elevation was reported).

⁷ However, we can estimate the dimensions of the grave's cut as ca. 0.70×0.90 cm.



Fig. 7.14 US 5 finds: pottery and objects.

Catalogue of US 5 Finds

*Objects***AbT.12.5 - Fig. 7.14**

Description: porous limestone spouted vessel. 0.4 cm; wall th.: 0.5 cm; base diam.: 5.2 cm; base th.: 2.4 cm; h.: 20 cm.

Dimensions: 15x7.4x21.7 cm.

Clay: outer colour (self-slip): 10YR 8/2 (very pale brown); inner and fabric colour: 5YR 5/4 (reddish brown); sand inclusions; medium-low firing temperature.

*Pottery***AbT.12.5.1 - Fig. 7.14**

Dimensions: wall th.: 0.8 cm; base diam.: 6 cm; base th.: 0.5 cm.

Clay: outer colour (self-slip): 10YR 8/2 (very pale brown); inner and fabric colour: 10YR 7/4 (very pale brown); sand inclusions; medium firing temperature.

Description: convex base jar (rim not preserved).

Description: plain rim jar.

AbT.12.5.3 - Fig. 7.14

Dimensions: rim diam.: 15.6 cm; rim th.: 0.5 cm; wall th.: 0.7 cm; base diam.: 5.4 cm; base th.: 0.8 cm; h.: 6.6 cm.

Clay: outer and inner colour (self-slip): 10YR 8/3 (very pale brown); fabric colour: 10YR 8/3 (very pale brown); sand inclusions; medium-high firing temperature.

AbT.12.5.2 - Fig. 7.14

Dimensions: rim diam.: 7 cm; rim th.:

Description: conical bowl.

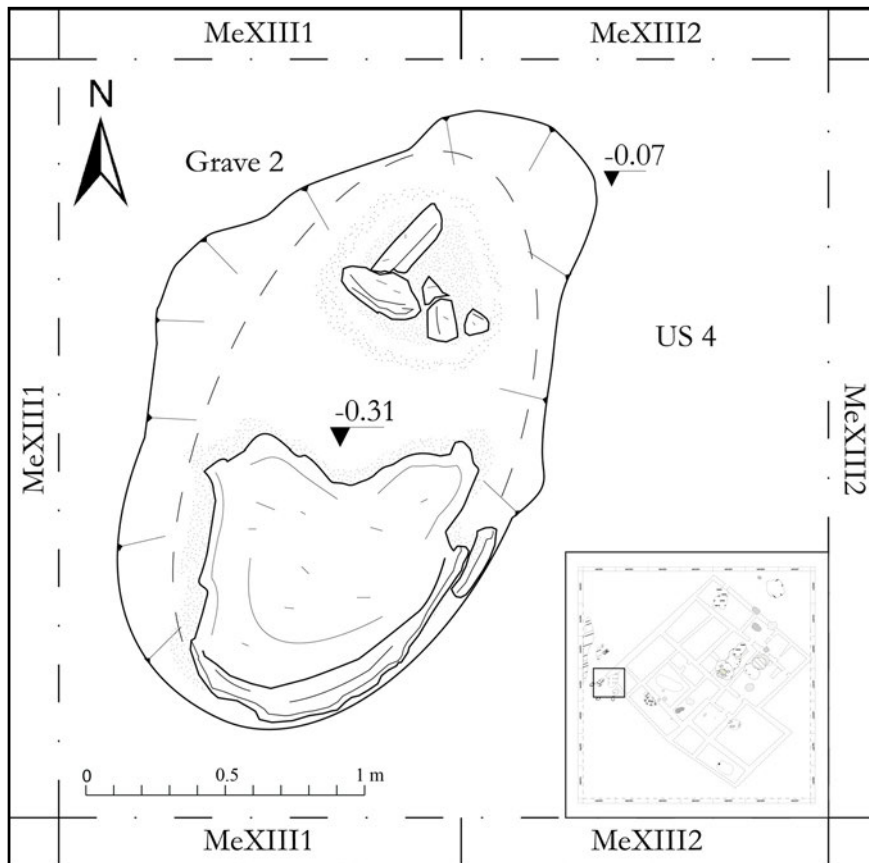

Fig. 7.15 Grave 2 plan.

7.1.3 GRAVE 2 [LR]

Grave 2 (Figs 7.15-16),⁸ located in the middle of squares MeXIII1-2 immediately under the surface (-0.07 m of elevation), was pillaged in antiquity and emptied of both the skeleton and the equipment (US 23; 9; 10; 11). Only part of the pottery sarcophagus was found *in situ*, while other fragments were discarded in the silty and quite compact soil, filling the robber pit.

A lapislazuli bead and an unfinished ornament were found in the backfill, hinting at the original richness of the burial. The coiled sarcophagus (US 10) was realized in coarse pottery and was oval in shape, with a flat base and three applied ridges on the wall.⁹

⁸ After the discovery of other coffins in the area, the first interpretation of US 10 was confirmed (see the previous interpretation in D'Agostino *et al.* 2011: 27-28).

⁹ The base was preserved for a length of 1 m.



Fig. 7.16 Grave 2 coffin.

Catalogue of US 10 Finds

Pottery

AbT.12.10.1 - Fig. 7.16

Dimensions: rim diam.: 42.7 cm; rim th.: 2,7 cm; wall th.: 1.5 cm; base diam.: 30 cm; base th.: 2.1 cm; h.: 40.8 cm.

Clay: outer, inner and fabric colour: 5Y 6/3 (pale olive); sand and vegetal inclusions; medium-high firing temperature.

Description: coiled coffin with flat base and three applied ridges.

Catalogue of US 23 Finds

Objects

AbT.12.14 - Fig. 7.17

Description: lapis lazuli bead.
Dimensions: 0.8x0.5x0.4 cm.

AbT.12.42 - Fig. 7.17

Description: unfinished ornament, greenish stone with dark thin veins (serpentine?).

Dimensions: 1x2 cm.

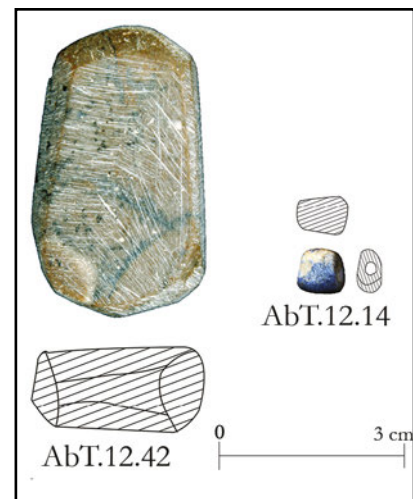

Fig. 7.17 US 23 objects.

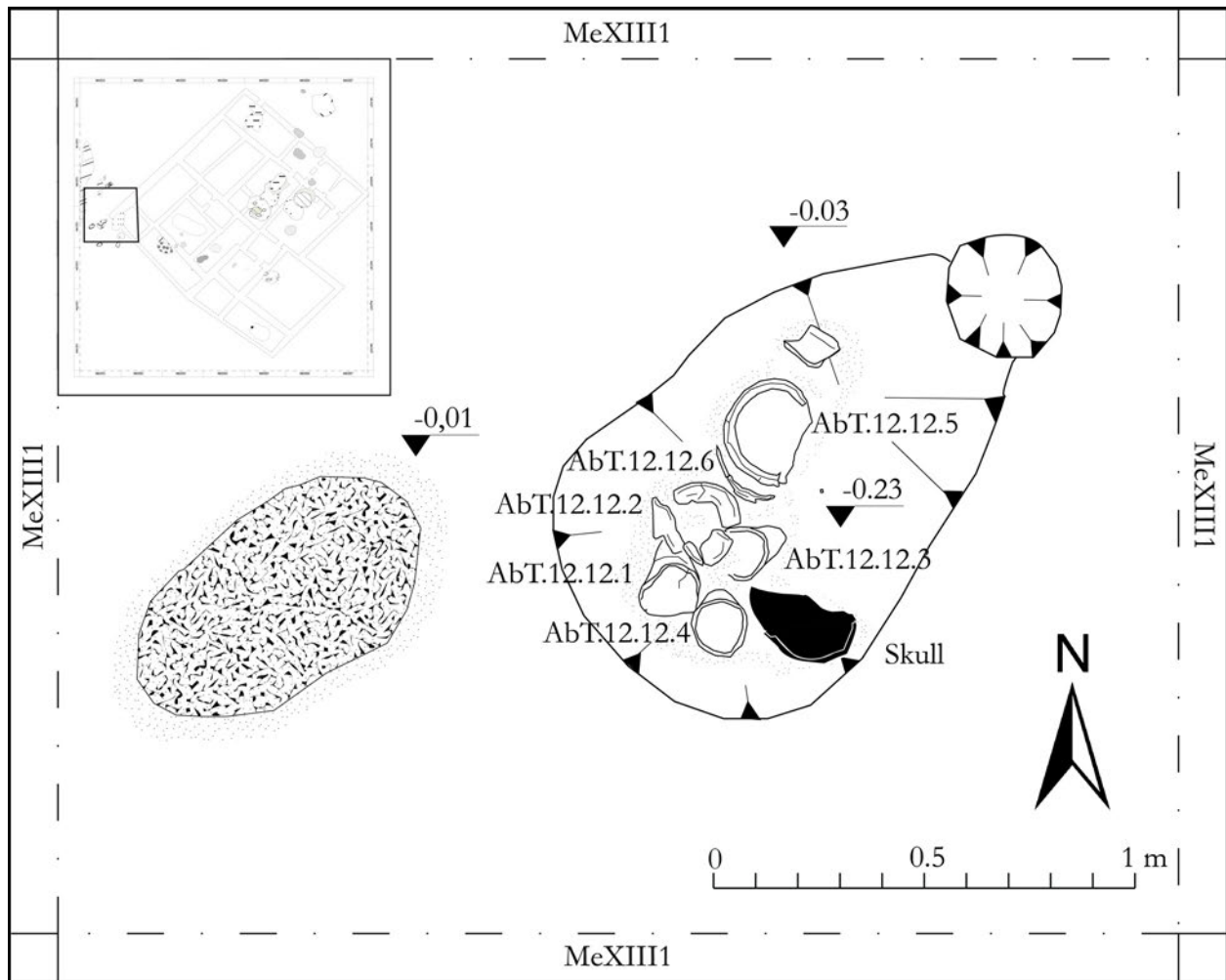

Fig. 7.18 Grave 3 plan.

7.1.4 GRAVE 3 [LR]

Grave 3 (Figs 7.18-19) was found during the first campaign, immediately under the surface, in square MeXIII1 (elevation of the upper part -0.03 m, bottom -0.23 m). A small hole (US 15), of 30 cm ca. of diameter and 20 cm deep, cut the grave near its north-east limits and was filled by a greyish ashy soil (US 24).

The grave cut (US 11) was oval-shaped, with south-west/north-east orientation, larger on the top and tapering down, with a more marked inclination in the southern part. The filling (US 12) consisted of a quite compact, yellowish-brown clay soil with small charcoals and mud-brick fragments. The pit contained only a portion of the skull and one tooth, clearly in secondary deposition. The equipment consisted of 4 beakers, 1 jar and 2 conical bowls. The drinking vessels were deposited together north-west of the skull, while the jar was located northward, beyond the bowls and beakers.



Fig. 7.19 Grave 3.

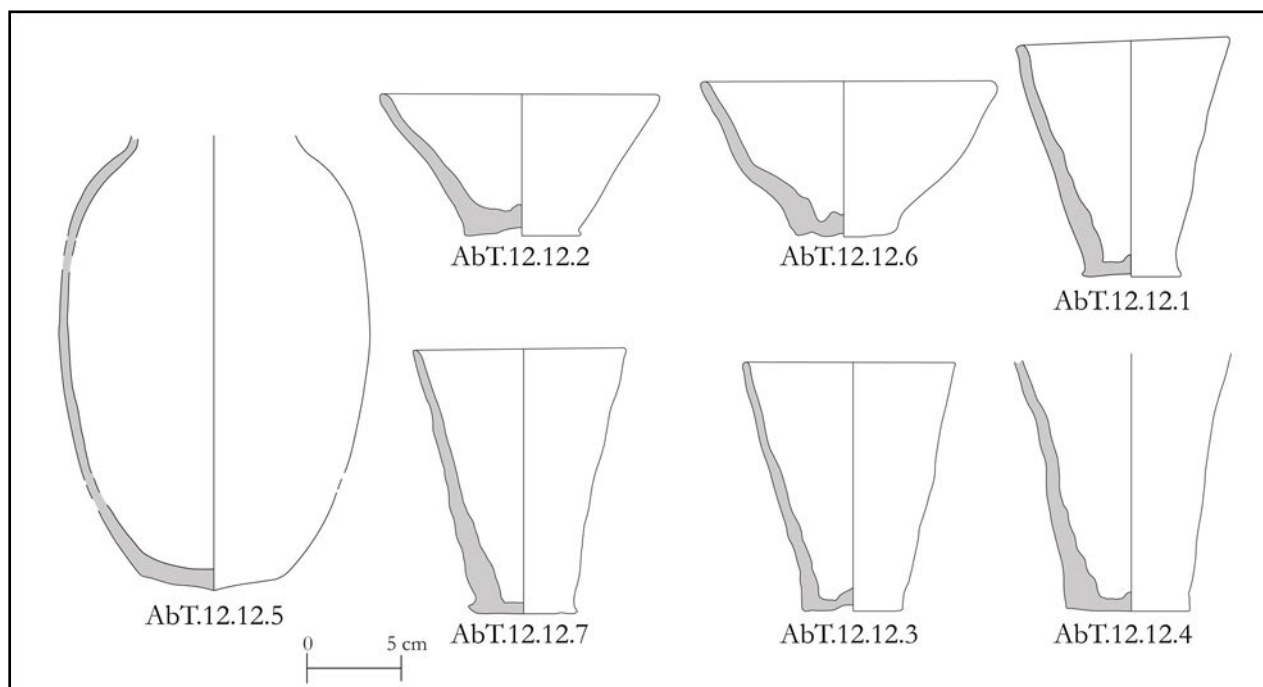

Fig. 7.20 US 12 pottery.

Catalogue of US 12 Finds

Pottery

AbT.12.12.1 - Fig. 7.20

Dimensions: rim diam.: 10.7 cm; rim th.: 0.5 cm; wall th.: 0.9 cm; base diam.: 5.1 cm; base th.: 1 cm; h.: 12.5 cm.

Clay: outer and inner colour: 7.5YR 7/4 (pink); fabric colour: 5YR 5/4 (reddish brown); sand inclusions; medium-low firing temperature.

Description: beaker.

AbT.12.12.2 - Fig. 7.20

Dimensions: rim diam.: 14.3 cm; rim th.: 0.5 cm; wall th.: 0.8 cm; base diam.: 5.8 cm; base th.: 1.2 cm; h.: 7.4 cm.

Clay: outer, inner and fabric colour: 5YR 6/3 (light reddish brown); sand inclusions; low firing temperature.

Description: conical bowl.

AbT.12.12.3 - Fig. 7.20

Dimensions: rim diam.: 10.8 cm; rim th.: 0.35 cm; wall th.: 0.7 cm; base diam.: 5 cm; base th.: 1.2 cm; h.: 13 cm.

Clay: outer, inner and fabric colour: 5YR 6/3 (light reddish brown); sand inclusions; medium-low firing

temperature.

Description: beaker.

AbT.12.12.4 - Fig. 7.20

Dimensions: wall th.: 0.5 cm; base diam.: 6.3 cm; base th.: 1 cm.

Clay: outer, inner and fabric colour: 10YR 7/3 (very pale brown); sand inclusions; medium-low firing temperature.

Description: beaker.

AbT.12.12.5 - Fig. 7.20

Dimensions: wall th.: 0.55 cm; base diam.: 7.5 cm; base th.: 1.15 cm.

Clay: outer, inner and fabric colour: 10YR 7/4 (very pale brown); sand inclusions; medium firing temperature.

Description: convex base jar (rim not preserved).

AbT.12.12.6 - Fig. 7.20

Dimensions: rim diam.: 15 cm; rim th.: 0.5 cm; wall th.: 0.9 cm; base diam.: 5 cm; base th.: 1.1 cm; h.: 8.1 cm.

Clay: outer, inner and fabric colour: 5YR

6/6 (reddish yellow); sand inclusions; medium-low firing temperature.

Description: conical bowl.

AbT.12.12.7 - Fig. 7.20

Dimensions: rim diam.: 11 cm; rim th.: 0.4 cm; wall th.: 0.9 cm; base diam.: 5.2 cm; base th.: 0.6 cm; h.: 13.7 cm.

Clay: outer, inner and fabric colour: 5YR 6/6 (reddish yellow); sand inclusions; medium-low firing temperature.

Description: beaker.

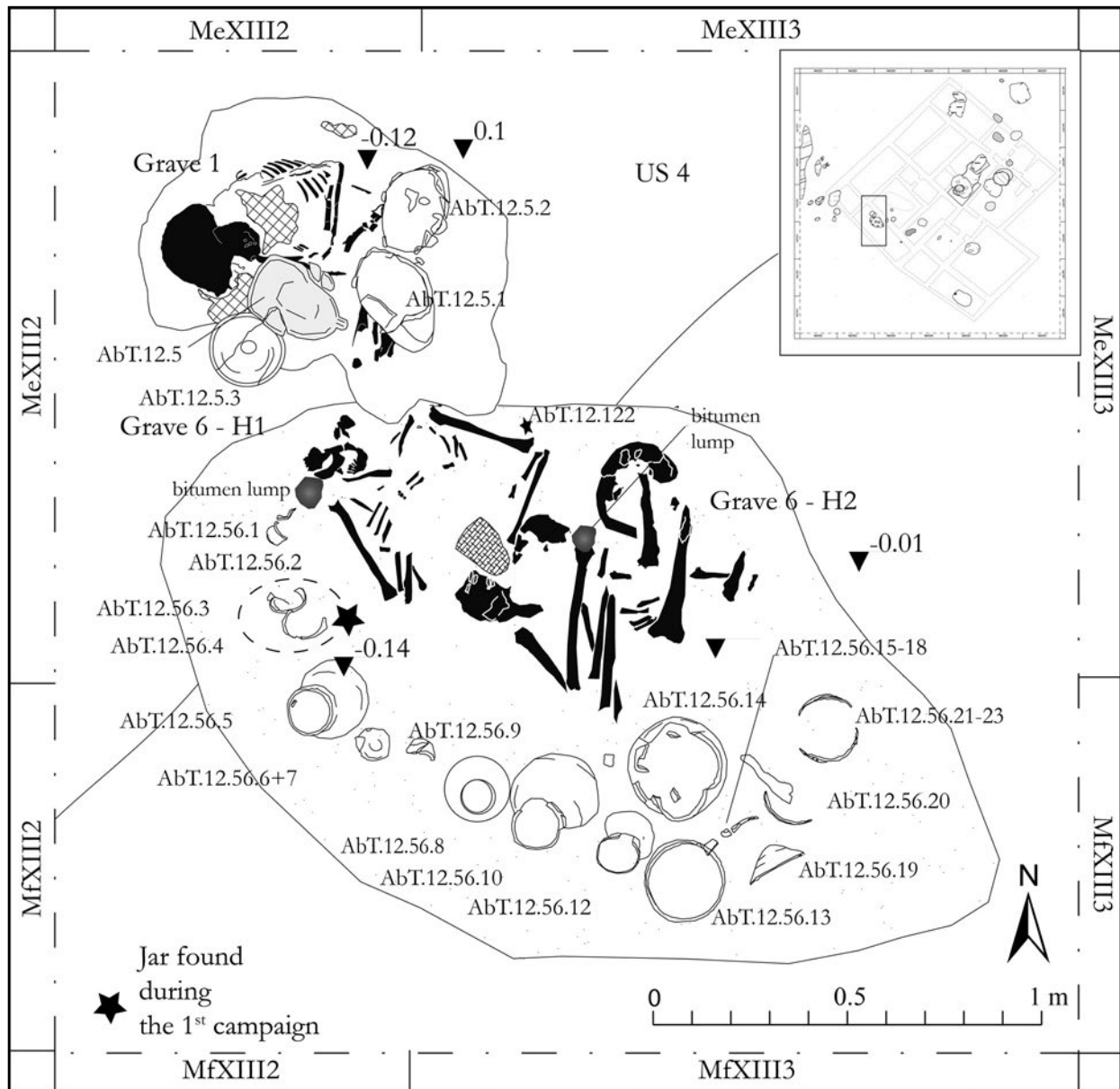

Fig. 7.21 Grave 1 and 6 plan.

7.1.5 GRAVE 6 [LR]

Grave 6 (Figs 7.21-22), a double inhumation, cut immediately under the surface in Me-fXIII2+3 (at the elevation of -0.01 m ca.), was found during the second campaign.¹⁰ The clay soil inside the grave (US 56) was light yellowish brown and compact, clearly differentiating itself from the underlying strata. Mudbricks and charcoal fragments, bitumen pieces, burnt shells and fishbones were scattered in the soil and inside some of the pottery vessels.¹¹

The grave cut (US 57) hosted two bodies, one in primary and the other in secondary deposition. The first one, the body of a woman (US 55), was laying down in a semi-flexed position with the head toward west and looking south, the legs towards south, the arms bent and the hands over the hips holding a vessel made of organic material. On top of the feet of the woman, the bones of male individual (US 66) were clearly re-deposited after the woman's inhumation.¹² The analysis of the two

¹⁰ See D'Agostino *et al.* 2013: 69-72.

¹¹ AbT.12.56.2, 13, 16, 19.

¹² The bones of both the bodies were in a very bad state of preservation. The excavation of the cluster of bones deposited at the feet of the woman was recovered cutting the

bodies revealed a common skeletal malformation, confirming the strong relationship among the two inhumed bodies (see § 12.2.1.4).

The pottery equipment, partially eroded due to the proximity to the surface, was deposited along the right side of the body, south-west and south of it, apparently in two rows. It included at least 14 drinking vessels, 8 medium/big jars¹³ and a miniaturistic vessel.¹⁴ The deposition of the pottery equipment seems to have followed a specific pattern: a conical bowl (AbT.12.56.1) and the miniaturistic jar were placed near the head of the deceased, while all the jars were deposited along the body, in one case with a bowl used as a lid (AbT.12.56.7 and AbT.12.56.6). With the exception of the beaker rim fragment AbT.12.56.9, all the drinking vessels were found south-east of the feet of the woman, some of them were one inside the other.

After the discovery, two of the jars (AbT.12.56.5 and 8) stored in the dig-house, started soaking through their walls an apparently greasy perspiration¹⁵. This “sweat” was sampled through the use of swabs and then analyzed in laboratory. The FTIR analyses made by S. Nunziante Cesaro revealed at least for one of the two jars the presence of an organic substance: further analyses will attempt to clarify the nature of the vessel content.

The other finds inside US 56 comprised a copper alloy fragment and sickle blade with part of its handle still preserved: none of these finds can surely be attributed to the grave equipment, being probably in secondary deposition. In addition, two pieces of bitumen mixed to vegetal temper was found, one near the head, the other near the left leg.

portion of soil and then moved to the dig-house for a more careful excavation in the laboratory.

¹³ Probably another jar was part of the equipment. It was found during the 1st campaign and left in situ covered with soil but after the few months between the 1st and the 2nd campaign we found no trace of it. The position of the jar however was recorded in Fig. 7.21.

¹⁴ In the US 56 catalogue a total of 33 pottery shards is presented: it also includes some pottery fragments from the backfill that probably do not belong to the equipment.

¹⁵ Probably the copious rainfalls and humidity that characterized 2012 Winter caused this phenomenon.



Fig. 7.22 Grave 6.

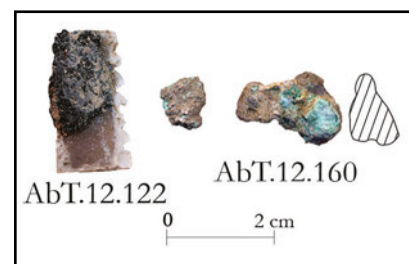

Fig. 7.23 US 56 objects.

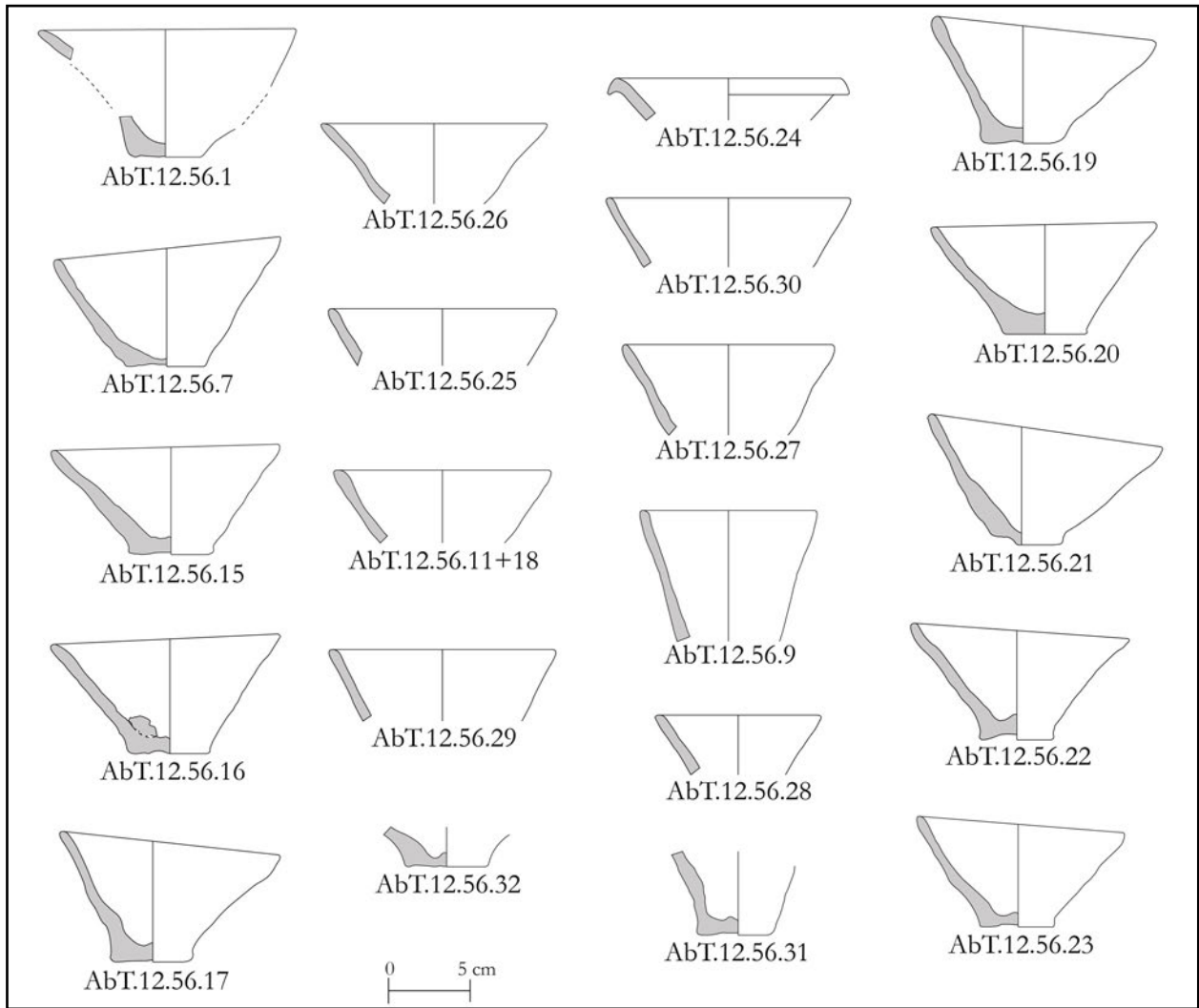

Fig. 7.24 US 56 pottery: open shapes.

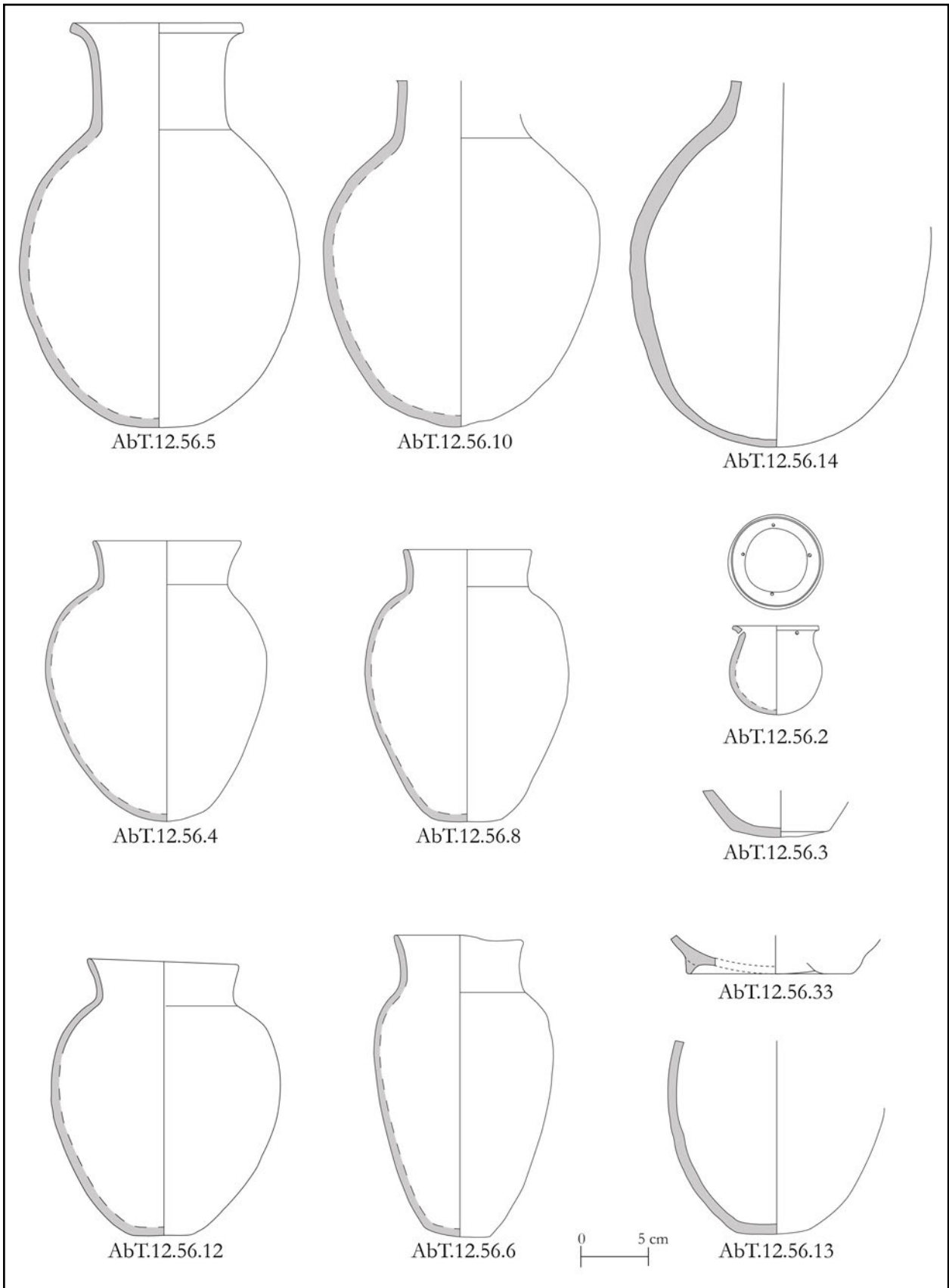

Fig. 7.25 US 56 pottery: closed shapes.

Catalogue of US 56 Finds

*Objects***AbT.12.122 - Fig. 7.23**

Description: chert sickle element. traces of bitumen used for hafting.
Dimensions: 1.37x2.74x3.8 cm.

AbT.12.160 - Fig. 7.23

Description: copper-alloy object fragment.
Dimensions: 2.03x1.4x1.4 cm.

*Pottery***AbT.12.56.1 - Fig. 7.24**

Dimensions: rim diam.: 16 cm; rim th.: 0.7 cm; wall th.: 0.9 cm; base diam.: 4.5 cm; base th.: 0.8 cm; h.: 8 cm (reconstructed).
Clay: outer, inner and fabric colour: 7.5YR 5/4 (brown); sand inclusions; low firing temperature.
Description: conical bowl. Found near AbT.12.56.2.

AbT.12.56.2 - Fig. 7.25

Dimensions: rim diam.: 6.5 cm; rim th.: 0.5 cm; wall th.: 0.5 cm; base diam.: 7 cm; base th.: 0.6 cm; h.: 6.6 cm.
Clay: outer colour: 7.5YR 6/4 (light brown); sand inclusions; medium-high firing temperature.
Description: miniaturistic jar, with a flared out-turned rim, globular body and rounded base. Four holes just below the rim. Found between AbT.12.56.1 and AbT.12.56.3. Fish bones in the filling of the vessel.

AbT.12.56.3 - Fig. 7.25

Dimensions: wall th.: 0.7 cm; base diam.: 7-7.4 cm; base th.: 0.6 cm.
Clay: outer colour: 7.5YR 6/4 (light brown); sand inclusions; medium-low firing temperature.
Description: convex base. Found between AbT.12.56.2 and AbT.12.56.4.

AbT.12.56.4 - Fig. 7.25

Dimensions: rim diam.: 11 cm; rim th.: 0.4 cm; wall th.: 0.5 cm; base diam.: 5.3 cm; base th.: 0.6 cm; h.: 20.6 cm.
Clay: outer and inner colour (slip): 5YR 8/2 (pinkish white); fabric colour: 2.5YR 4/4 (reddish brown); sand inclusions; medium-low firing temperature.

Description: plain rim jar. Found between AbT.12.56.3 and AbT.12.56.5.

AbT.12.56.5 - Fig. 7.25

Dimensions: rim diam.: 12.6 cm; rim th.: 0.8 cm; wall th.: 0.6 cm; base diam.: 10 cm; base th.: 0.7 cm; h.: 29.8 cm.
Clay: outer colour ("reserved-slip like" effect): 2.5Y 8/2 (pale brown); fabric colour: 7.5YR 6/3 (light brown); sand inclusions; medium firing temperature.
Description: triangular rim jar. Found between AbT.12.56.4 and AbT.12.56.6 and AbT.12.56.7.

AbT.12.56.6 - Fig. 7.25

Dimensions: rim diam.: 9 cm; rim th.: 0.4 cm; wall th.: 0.55 cm; base diam.: 5 cm; base th.: 0.6 cm; h.: 22 cm.
Clay: outer colour: 2.5Y 8/2 (pale brown); fabric colour: 2.5YR 6/6 (light red); sand inclusions; medium firing temperature.
Description: plain rim jar. Found under AbT.12.56.7, AbT.12.56.8 and AbT.12.56.9.

AbT.12.56.7 - Fig. 7.24

Dimensions: rim diam.: 14 cm; rim th.: 0.7 cm; wall th.: 0.6 cm; base diam.: 5 cm; base th.: 0.4 cm; h.: 8 cm.
Clay: outer and inner colour: 2.5Y 8/2 (pale brown); fabric colour: 5YR 6/4 (light reddish brown); sand inclusions; medium-low firing temperature.
Description: conical bowl. Found above AbT.12.56.6 and between AbT.12.56.5 and AbT.12.56.8 and AbT.12.56.9.

AbT.12.56.8 - Fig. 7.25

Dimensions: rim diam.: 9.5 cm; rim th.: 0.5 cm; wall th.: 0.5 cm; base diam.: 5.5 cm; h.: 20 cm.
Clay: outer and inner colour: 10YR 8/2 (very pale brown); fabric colour: 5YR 6/6 (reddish yellow); sand inclusions; medium-high firing temperature.
Description: plain rim jar. Found under AbT.12.56.9 and between AbT.12.56.7, AbT.12.56.8 and AbT.12.56.10.

AbT.12.56.9 - Fig. 7.24

Dimensions: rim diam.: 11 cm; rim th.: 0.6 cm; wall th.: 0.8 cm.
Clay: outer, inner and fabric colour: 10YR 6/4 (light yellowish brown); sand and vegetal inclusions; medium-high firing temperature.
Description: drinking vessel rim. Found above AbT.12.56.8.

AbT.12.56.10 - Fig. 7.25

Dimensions: wall th.: 0.8 cm; base diam.: ca. 10 cm; base th.: 0.8 cm.
Clay: outer colour: 2.5Y 8/2 (pale brown); fabric colour: 2.5YR 6/4 (light reddish brown); sand inclusions; medium-high firing temperature.
Description: jar with rounded shoulders and rounded base. Found near AbT.12.56.11 and between AbT.12.56.12 and AbT.12.56.9. Two rims of a conical bowl were found inside it.

AbT.12.56.11+18 - Fig. 7.24

Dimensions: rim diam.: 13.5 cm; rim th.: 0.75 cm; wall th.: 0.5 cm.
Clay: outer and inner colour: 2.5Y 8/2 (pale brown); fabric colour: 2.5YR 6/4 (light reddish brown); sand inclusions; medium-low firing temperature.
Description: drinking vessel rim. Found near AbT.12.56.10.

AbT.12.56.12 - Fig. 7.25

Dimensions: rim diam.: 11 cm; rim th.: 0.4 cm; wall th.: 0.5 cm; base diam.: 7 cm; h.: 20 cm.
Clay: outer and inner colour: 2.5Y 8/2 (pale brown); medium firing temperature.
Description: plain rim jar. Found between AbT.12.56.10, AbT.12.56.11, AbT.12.56.14 and AbT.12.56.13.

AbT.12.56.13 - Fig. 7.25

Dimensions: walls th.: 0.6 cm; base diam.: 16.7 cm; base th.: 0.8 cm.
Clay: outer and inner colour: 2.5Y 8/2 (pale brown); fabric colour: 5YR 6/6 (reddish yellow); sand inclusions; medium firing temperature.
Description: convex base. Found near AbT.12.56.12 and AbT.12.56.14. Fish bones inside it.

AbT.12.56.14 - Fig. 7.25

Dimensions: wall th.: 1.1 cm; base diam.: 11.5 cm; base th.: 0.5 cm.
Clay: outer, inner and fabric colour: 10YR 7/3 (very pale brown); sand inclusions; medium-high firing temperature.
Description: jar with rounded shoulders and rounded base. Found near AbT.12.56.12 and AbT.12.56.13. Conical bowl base and a single fish-bone inside it.

AbT.12.56.15 - Fig. 7.24

Dimensions: rim diam.: 14.3 cm; rim th.: 0.6 cm; wall th.: 0.9 cm; base diam.: 5 cm; base th.: 1 cm; h.: 6.6 cm.

Clay: outer colour and inner colour (self-slip): 2.5Y 8/2 (pale brown); fabric colour: 5YR 5/4 (reddish brown); sand inclusions; medium-low firing temperature.

Description: conical bowl. Containing AbT.12.56.16.

AbT.12.56.16 - Fig. 7.24 and 10.20

Dimensions: rim diam.: 14.3 cm; rim th.: 0.65 cm; wall th.: 0.65 cm; base diam.: 5 cm; base th.: 1 cm; h.: 7 cm.

Clay: outer, inner and fabric colour: 2.5YR 6/6 (light red); sand inclusions; medium-low firing temperature.

Description: conical bowl. Found inside AbT.12.56.15. A fish-bone in the clay lumps inside the bowl. A piece of extra clay left inside.

AbT.12.56.17 - Fig. 7.24

Dimensions: rim diam.: 14.4 cm; rim th.: 0.6 cm; wall th.: 0.8 cm; base diam.: 5 cm; base th.: 1 cm; h.: 7.5 cm.

Clay: outer and inner colour: 2.5Y 8/2 (pale brown); sand inclusions; medium firing temperature.

Description: conical bowl. Found near AbT.12.56.16, AbT.12.56.18 and AbT.12.56.15.

AbT.12.56.18=AbT.12.56.11**AbT.12.56.19 - Fig. 7.24**

Dimensions: rim diam.: 14 cm; rim th.: 0.7 cm; wall th.: 0.8 cm; base diam.: 5 cm; base th.: 1 cm; h.: 8 cm.

Clay: outer and inner colour: 2.5Y 8/2 (pale brown); sand inclusions; medium firing temperature.

Description: conical bowl. Found near AbT.12.56.13. A fish bone inside it.

AbT.12.56.20 - Fig. 7.24

Dimensions: rim diam.: 14 cm; rim th.: 0.5 cm; wall th.: 0.8 cm; base diam.: 5 cm; base th.: 1.2 cm; h.: 7 cm.

Clay: outer, inner and fabric colour: 2.5YR 6/6 (light red); sand inclusions; medium-low firing temperature.

Description: conical bowl. Found near AbT.12.56.15-16-17-18.

AbT.12.56.21 - Fig. 7.24

Dimensions: rim diam.: 14 cm; rim th.: 0.65 cm; wall th.: 0.8 cm; base diam.:

5.5 cm; base th.: 0.8 cm; h.: 7.6 cm.

Clay: outer and inner colour: 2.5Y 8/2 (pale brown); fabric colour: 2.5YR 6/6 (light red); sand inclusions; medium-low firing temperature.

Description: conical bowl. Found under AbT.12.56.22 and with AbT.12.56.23.

AbT.12.56.22 - Fig. 7.24

Dimensions: rim diam.: 13.5 cm; rim th.: 0.7 cm; wall th.: 0.7 cm; base diam.: 4.7 cm; base th.: 1.2 cm; h.: 7.9 cm.

Clay: outer, inner and fabric colour: 2.5YR 5/6 (red); sand inclusions; medium-low firing temperature.

Description: conical bowl. Found inside AbT.12.56.21 and with AbT.12.56.23.

AbT.12.56.23 - Fig. 7.24

Dimensions: rim diam.: 13 cm; rim th.: 0.65 cm; wall th.: 0.7 cm; base diam.: 4.5 cm; base th.: 1 cm; h.: 7 cm.

Clay: outer, inner and fabric colour: 2.5YR 4/4 (reddish brown); sand inclusions; medium-low firing temperature.

Description: conical bowl. Found with AbT.12.56.21 and AbT.12.56.22.

AbT.12.56.24 - Fig. 7.24

Dimensions: rim diam.: 14 cm; rim th.: 1.2 cm; wall th.: 0.7 cm.

Clay: outer, inner and fabric colour: 2.5YR 5/6 (red); sand inclusions; medium-high firing temperature.

Description: triangular rim bowl. Found near the skull.

AbT.12.56.25 - Fig. 7.24

Dimensions: rim diam.: 14 cm; rim th.: 0.6 cm; wall th.: 0.6 cm.

Clay: outer, inner and fabric colour: 10YR 6/3 (pale brown); sand inclusions; medium firing temperature.

Description: drinking vessel rim.

AbT.12.56.26 - Fig. 7.24

Dimensions: rim diam.: 14 cm; rim th.: 0.6 cm; wall th.: 0.55 cm.

Clay: outer, inner and fabric colour: 5YR 5/4 (reddish brown); sand inclusions; medium-low firing temperature.

Description: drinking vessel rim.

AbT.12.56.27 - Fig. 7.24

Dimensions: rim diam.: 13 cm; rim th.: 0.7 cm; wall th.: 0.75 cm.

Clay: outer, inner and fabric colour: 7.5YR 6/4 (light brown); sand

inclusions; medium firing temperature. Description: drinking vessel rim.

AbT.12.56.28 - Fig. 7.24

Dimensions: rim diam.: 10 cm; rim th.: 0.6 cm; wall th.: 0.6 cm.

Clay: outer and inner colour: 10YR 8/2 (very pale brown); fabric colour: 7.5YR 6/4 (light brown); sand inclusions; medium-high firing temperature.

Description: drinking vessel rim.

AbT.12.56.29 - Fig. 7.24

Dimensions: rim diam.: 14 cm; rim th.: 0.6 cm; wall th.: 0.65 cm.

Clay: outer, inner and fabric colour: 2.5Y 8/3 (pale brown); sand inclusions; medium-high firing temperature.

Description: drinking vessel rim.

AbT.12.56.30 - Fig. 7.24

Dimensions: rim diam.: 15 cm; rim th.: 0.5 cm; wall th.: 0.55 cm.

Clay: outer, inner and fabric colour: 7.5YR 7/4 (pink); sand inclusions; medium-low firing temperature.

Description: drinking vessel rim.

AbT.12.56.31 - Fig. 7.24

Dimensions: wall th.: 0.9 cm; base diam.: 5 cm; base th.: 1 cm.

Clay: outer, inner and fabric colour: 5YR 5/6 (yellowish red); sand inclusions; medium-low firing temperature.

Description: beaker base.

AbT.12.56.32 - Fig. 7.24

Dimensions: wall th.: 1 cm; base diam.: 5 cm; base th.: 0.8 cm.

Clay: outer, inner and fabric colour: 7.5YR 7/4 (pink); sand inclusions; medium-low firing temperature.

Description: conical bowl base.

AbT.12.56.33 - Fig. 7.25

Dimensions: base diam.: 13 cm; base th.: 0.7 cm.

Clay: outer, inner and fabric colour: 10YR 8/4 (very pale brown); sand inclusions; medium-high firing temperature.

Description: ring base.

7.1.6 GRAVE 11 [LR]

Grave 11 (MfXIII3 - Figs 7.26-27) is a simple pit inhumation of an infant of perinatal age (US 130-131-132).¹⁶ The yellowish brown clay soil that filled the cut (US 130) was rich of pure clay lumps and also contained some pieces of reed-mat.¹⁷ The shallow cut (20 cm deep) was identified at an elevation of -0.09 m, immediately under the surface.

The child (US 131) was deposited in an apparently semi-flexed position with the head towards west and looking south. No grave goods accompanied the body.

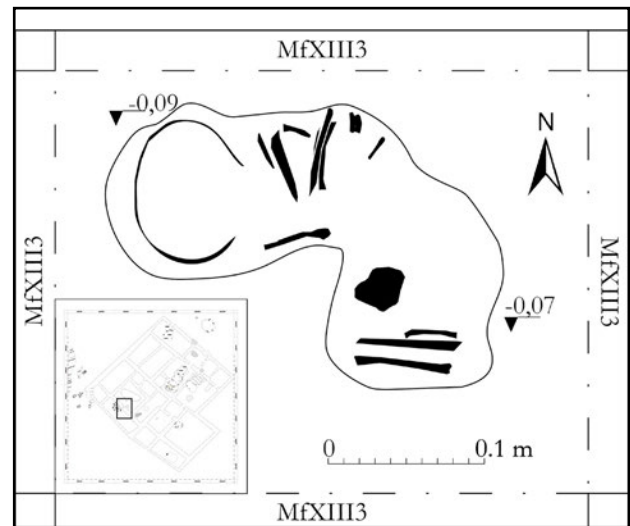

Fig. 7.26 Grave 11 plan.



Fig. 7.27 Grave 11.

¹⁶ See also D'Agostino *et al.* 2015: 210; 2016: 48.

¹⁷ It is not clear if the body was wrapped with a reed-mat.

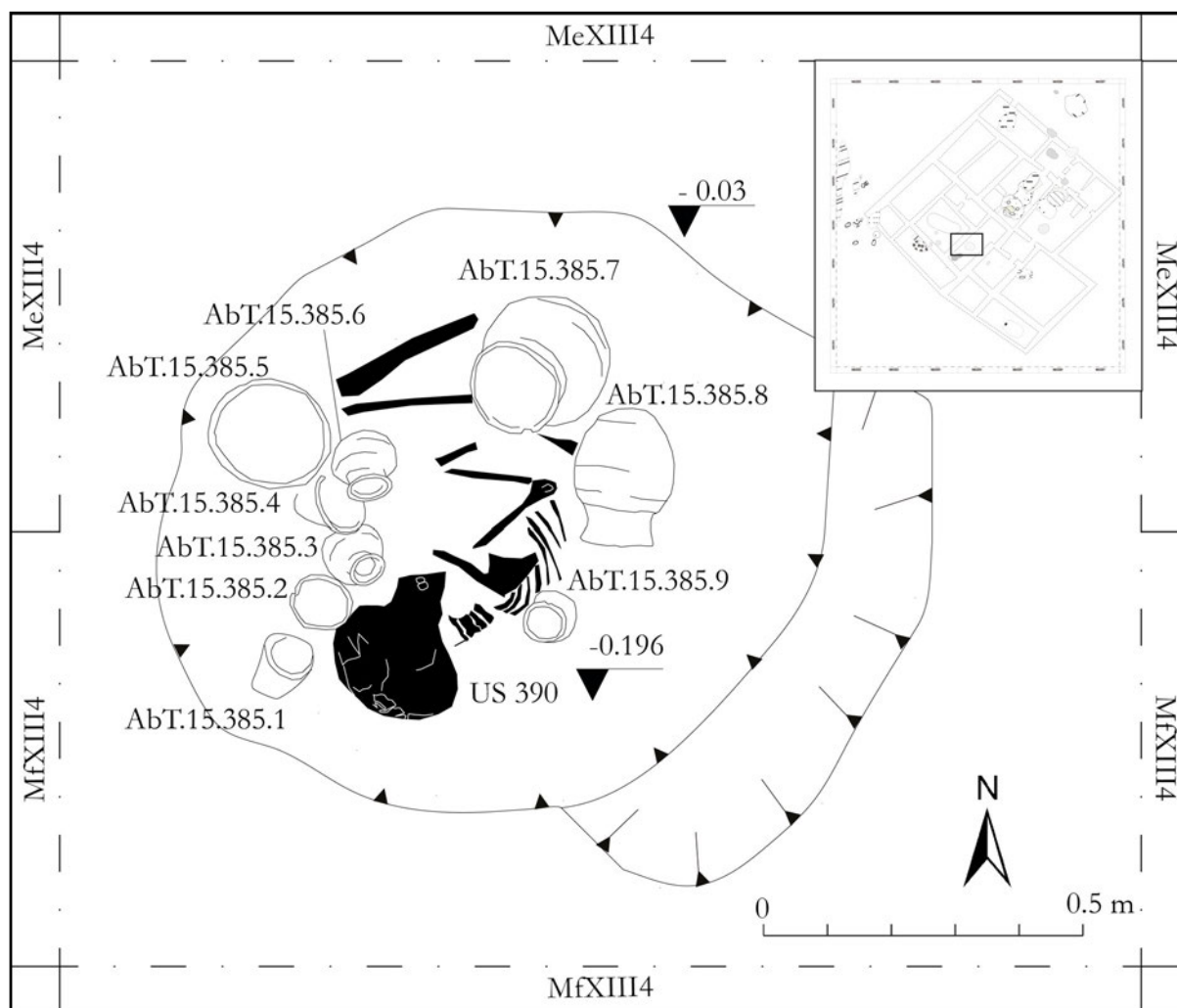

7.1.7 GRAVE 25 [LR]

The inhumation was located in Me-fXIII4 at the elevation of -0.03 m (Figs 7.28-29). The shallow cut (US 386) was used to host the skeleton of a child (US 390), deposited in semi-flexed position on his left side, with the head toward south, looking north-west.

The right arm was bent on the chest and the left one stretched out along the body. The body was probably wrapped in reed-mat, traces of which were preserved only between the skeleton and the jar AbT.15.385.8.

A quite soft, reddish-brown and silty-clay soil (US 385) covered the equipment, consisting of several pottery vessels, mostly miniaturistic shapes. While the bigger jars were at the feet of the body, the miniaturistic vessels and the conical bowls were all deposited near the head, with the exception of AbT.15.385.9, a miniaturistic jar placed behind the right shoulder.

Fig. 7.28 Grave 25 plan (by M. Zingale).



Fig. 7.29 Grave 25.

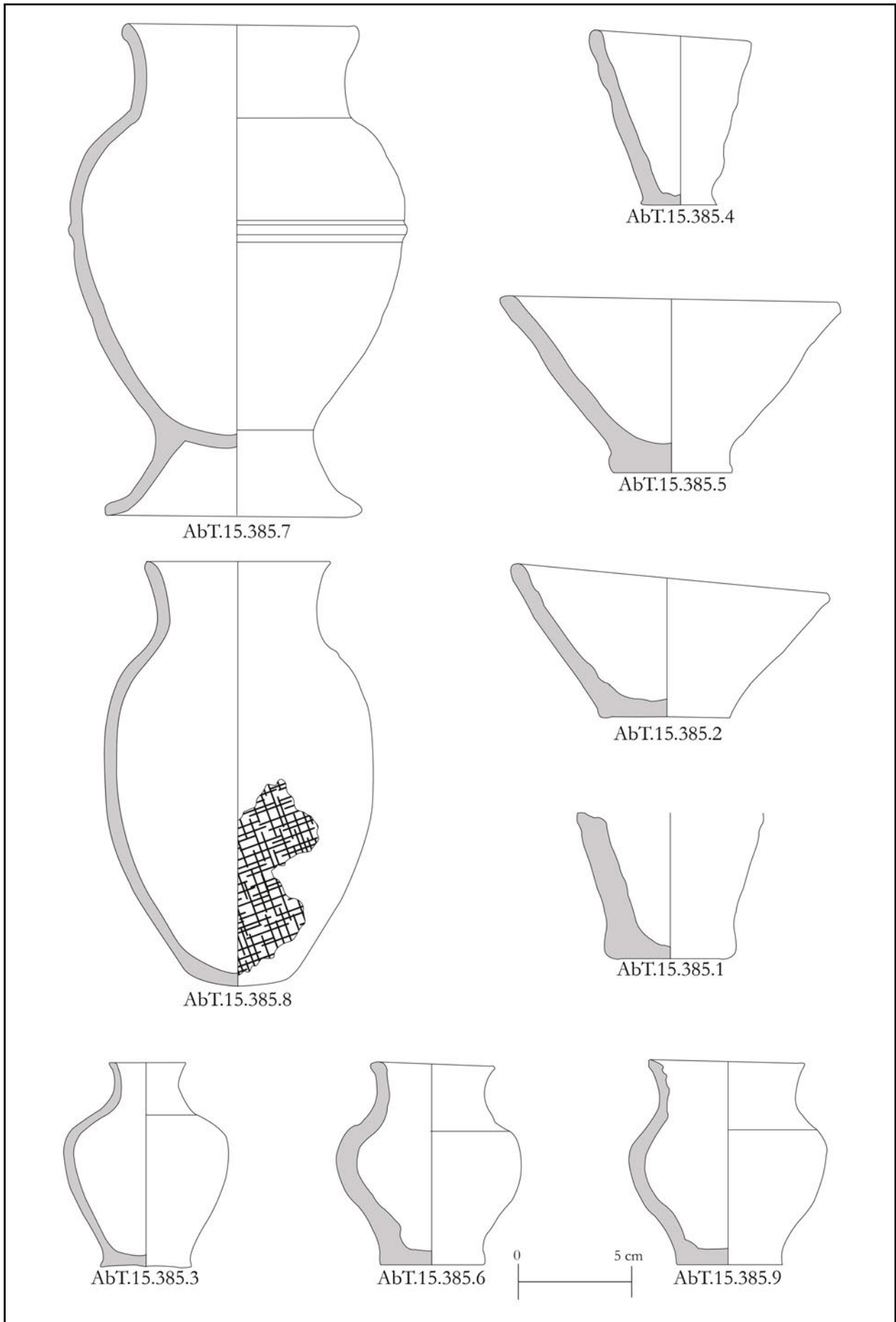

Fig. 7.30 US 385 pottery.

Catalogue of US 385 Finds

*Pottery***AbT.15.385.1 - Fig. 7.30**

Dimensions: wall th.: 1.1 cm; base diam.: 4.7 cm; base th.: 1 cm.

Clay: outer colour: 10YR 8/4 (very pale brown); inner colour: 10YR 6/3 (pale brown); fabric colour: 5YR 5/6 (yellowish red); sand inclusions; medium-low firing temperature.

Description: beaker base.

AbT.15.385.2 - Fig. 7.30

Dimensions: rim diam.: 14.3 cm; rim th.: 0.7 cm; wall th.: 0.7 cm; base diam.: 5.8 cm; base th.: 0.8 cm; h.: 6.8 cm.

Clay: outer, inner and fabric colour: 5YR 5/4 (reddish brown); sand inclusions; medium-low firing temperature.

Description: conical bowl.

AbT.15.385.3 - Fig. 7.30

Dimensions: rim diam.: 4 cm; rim th.: 0.3 cm; wall th.: 0.3 cm; base diam.: 3.5 cm; base th.: 0.4 cm; h.: 9.3 cm.

Clay: outer and inner colour: 10YR 8/2 (very pale brown); sand inclusions; medium firing temperature.

Description: miniaturistic jar.

AbT.15.385.4 - Fig. 7.30

Dimensions: rim diam.: 8 cm; rim th.: 0.52 cm; wall th.: 0.6 cm; base diam.:

3.5 cm; base th.: 0.5 cm; h.: 7.5 cm.

Clay: outer and inner colour: 10YR 8/2 (very pale brown); sand inclusions; medium-low firing temperature.

Description: miniaturistic beaker.

AbT.15.385.5 - Fig. 7.30

Dimensions: rim diam.: 14.8 cm; rim th.: 0.7 cm; wall th.: 0.8 cm; base diam.: 5.2 cm; base th.: 1.3 cm; h.: 7.5 cm.

Clay: outer and inner colour: 10YR 7/3 (very pale brown); sand inclusions; medium-low firing temperature.

Description: conical bowl.

AbT.15.385.6 - Fig. 7.30

Dimensions: rim diam.: 5.5 cm; rim th.: 0.4 cm; wall th.: 0.6 cm; base diam.: 4.7 cm; base th.: 0.7 cm; h.: 9 cm.

Clay: outer colour (slipped): 10YR 8/2 (very pale brown); inner colour: 2.5Y 8/4 (pale brown); sand inclusions; medium firing temperature.

Description: miniaturistic jar.

AbT.15.385.7 - Fig. 7.30

Dimensions: rim diam.: 10 cm; rim th.: 0.6 cm; wall th.: 0.8 cm; base diam.: 10 cm; base th.: 0.7 cm; h.: 21.4 cm.

Clay: outer colour: 10YR 8/2 (very pale brown); inner and fabric colour: 2.5YR 5/8 (red); sand inclusions; medium-low firing temperature.

Description: trumpet base jar.

AbT.15.385.8 - Fig. 7.30

Dimensions: rim diam.: 8 cm; rim th.: 0.5 cm; wall th.: 0.5 cm; base diam.: 3.5 cm; base th.: 0.7 cm; h.: 18.5 cm.

Clay: outer and inner colour (self-slipped?): 2.5Y 7/3 (pale brown); sand inclusions; medium firing temperature.

Description: plain rim jar with convex base. Traces of reed-mat preserved on the surface.

AbT.15.385.9 - Fig. 7.30

Dimensions: rim diam.: 6.6 cm; rim th.: 0.4 cm; wall th.: 0.7 cm; base diam.: 4.6 cm; base th.: 0.8 cm; h.: 8.9 cm.

Clay: outer and inner colour: 10YR 6/4 (light yellowish brown); sand inclusions; medium firing temperature.

Description: miniaturistic jar.

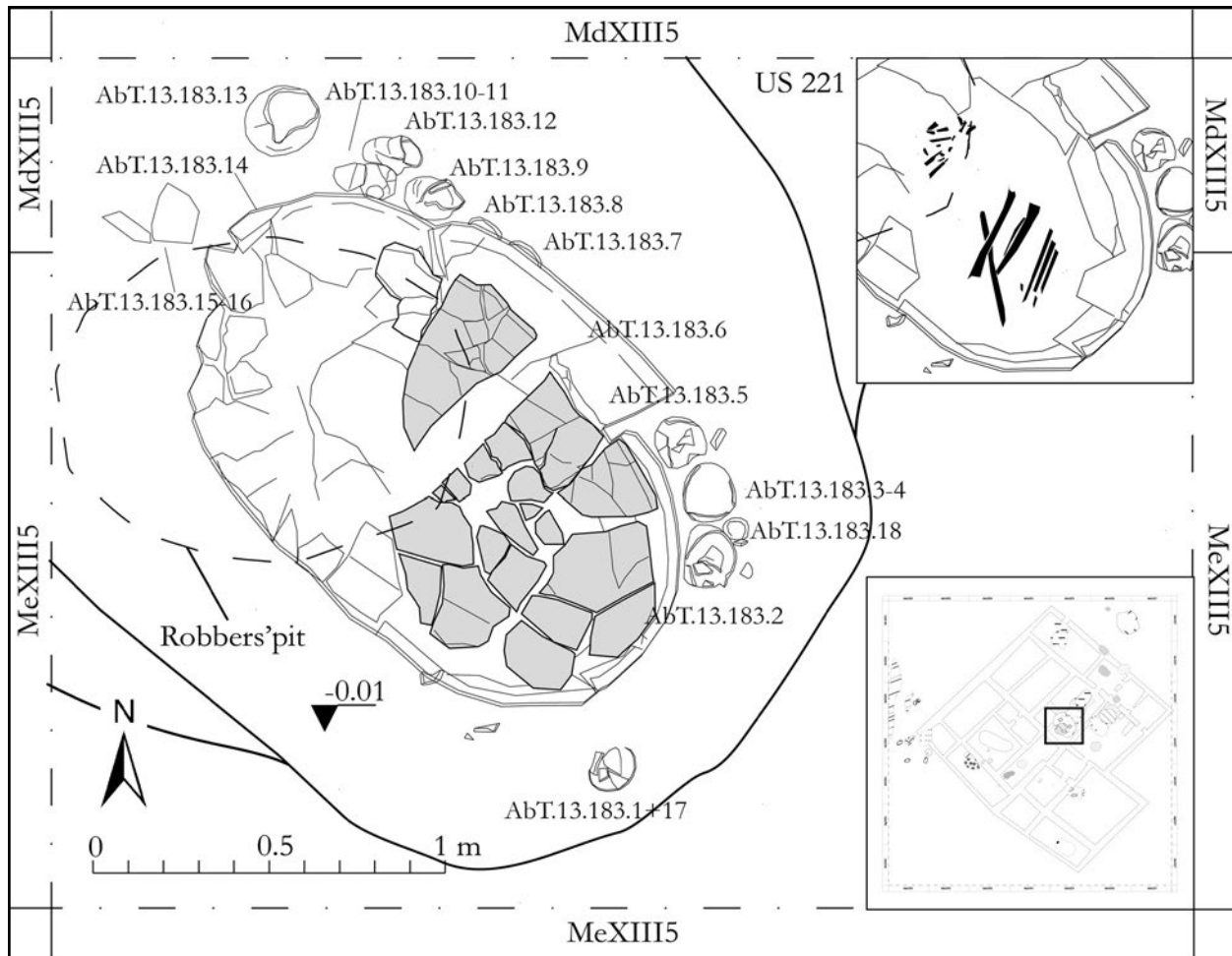

Fig. 7.31 Grave 15 plan.

7.2 MdXIII5+6+MeXIII5 [LR]

7.2.1 GRAVE 15 [LR]

Grave 15 (Figs 7.31-34),¹⁸ located in squares Md-xIII5, is an inhumation in a pottery coffin (US 184), robbed and partially destroyed in antiquity, but still preserving part of the lid in place (US 191-192). A shallow heap of dark greyish brown, soft and ashy-sandy soil (US 174; elevation 0.24 m) covered the grave. Inside this heap several pottery fragments were probably in secondary deposition. The coffin was positioned in a shallow cut (US 175; minimum elevation of the bottom -0.01 m) north-west to south-east, partially destroyed by ancient looters on its northwest half, where the lid was missing.¹⁹

Only the legs of an adult individual (undetermined sex US 190) were preserved, bent on the right side with the feet towards south-east,²⁰ in extremely bad conditions, probably due to the weight of the lid (US 189).

The pottery equipment was deposited only on the north-east and south-east side of the sarcophagus: it consisted of 8 bowls, 3 beakers and 7 jars.²¹ There is apparently no specific pattern in the deposition of the pottery vessels around the coffin. However, it should be noted that all the conical bowls were near the short side of the coffin, while the two beakers were placed long the longer side. Moreover,

¹⁸ See also D'Agostino *et al.* 2015: 211; 2016: 48.

¹⁹ The cut was deeper in its south-eastern part.

²⁰ It is possible to suppose that the head was located north-west, in correspondence of the looters hole.

²¹ The other fragments in the catalogue were in secondary deposition (some of them could also come from the lower dump pit - see § 7.2.3).



Fig. 7.32 Grave 15's coffin (US 184).



Fig. 7.33 Grave 15 skeleton (US 190).



Fig. 7.34 Grave 15 pottery.

the small beaker AbT.13.183.4 was found inside the jar AbT.13.183.3: it is possible that it was used as a sort of lid, as seen in Grave 6, or as a sort of dipper.

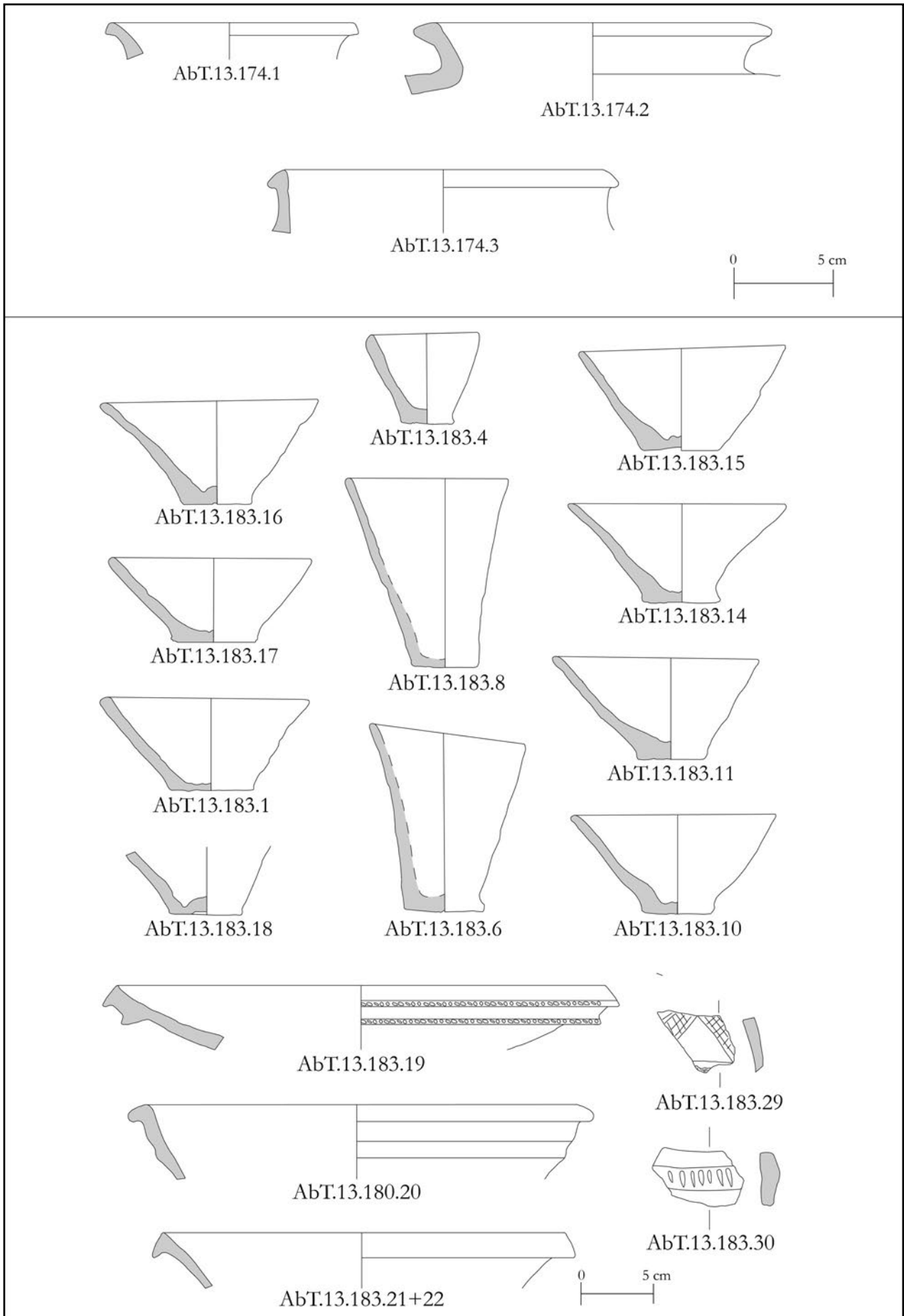

Fig. 7.35 US 174 and US 183 pottery: open shapes.

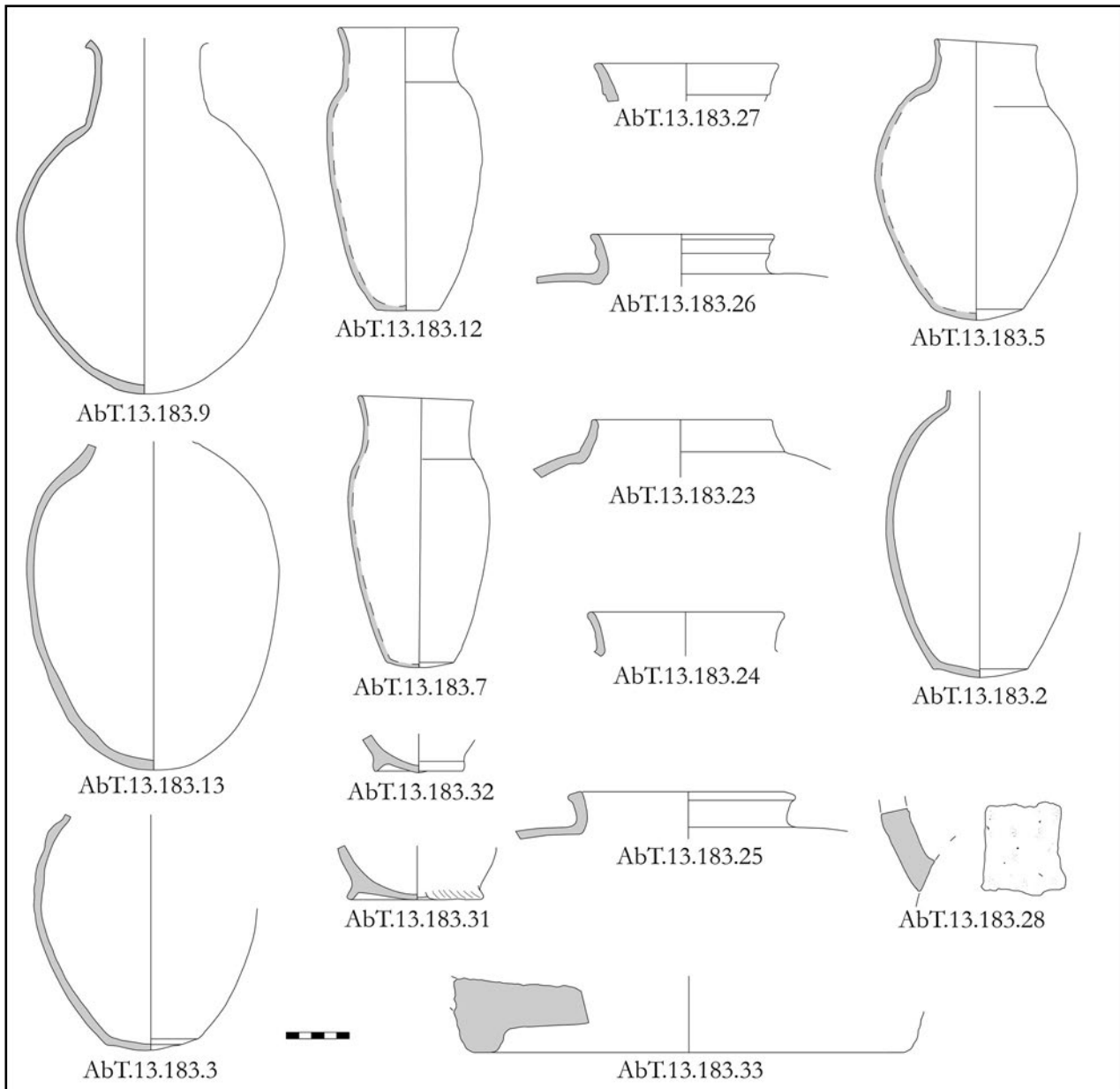

Fig. 7.36 US 183 pottery: closed and other shapes.

Catalogue of US 174 Finds

*Pottery***AbT.13.174.1 - Fig. 7.35**

Dimensions: rim diam.: 12 cm; rim th.: 0.7 cm; wall th.: 0.65 cm.

Clay: outer and inner colour: 2.5Y 8/3 (pale brown); fabric colour: 7.5YR 6/4 (light brown); sand inclusions; medium-low firing temperature.

Description: triangular rim jar.

AbT.13.174.2 - Fig. 7.35

Dimensions: rim diam.: 16 cm; rim th.: 1.4 cm; wall th.: 0.9 cm.

Clay: outer colour: 5Y 8/2 (pale yellow); inner colour: 2.5Y 8/4 (pale brown); fabric colour: 2.5Y 6/3 (light yellowish brown); sand inclusions; medium firing temperature.

Description: triangular rim jar.

AbT.13.174.3 - Fig. 7.35

Dimensions: rim diam.: 16 cm; rim th.: 1.25 cm; wall th.: 0.75 cm.

Clay: outer and inner colour: 5Y 6/3 (pale olive); fabric colour: 5Y 5/3 (olive); sand inclusions; high firing temperature.

Description: triangular rim jar.

Catalogue of US 183 Finds

*Pottery***AbT.13.183.1 - Fig. 7.35**

Dimensions: rim diam.: 15 cm; rim th.: 0.7 cm; wall th.: 0.8 cm; base diam.: 5.8 cm; base th.: 0.6 cm; h.: 6.7 cm.

Clay: outer, inner and fabric colour: 2.5YR 4/4 (reddish brown); sand inclusions; low firing temperature.

Description: conical bowl. Found south of the sarcophagus together with AbT.13.183.17.

AbT.13.183.2 - Fig. 7.36

Dimensions: wall th.: 0.5 cm; base diam.: 7 cm; base th.: 0.5 cm.

Clay: outer colour: 5YR 8/2 (pinkish white); inner colour: 5YR 6/4 (light reddish brown); fabric colour: 2.5YR 4/3 (reddish brown); sand inclusions; medium firing temperature.

Description: jar with reversed piriform body, rounded shoulders and convex base. Found south of the sarcophagus, near AbT.13.183.3.

AbT.13.183.3 - Fig. 7.36

Dimensions: wall th.: 0.6 cm; base diam.: 7 cm; base th.: 0.6 cm.

Clay: outer colour: 7.5YR 8/2 (pinkish white); inner colour: 5YR 6/6 (reddish yellow); fabric colour: 2.5YR 4/3 (reddish brown); sand inclusions; medium-low firing temperature.

Description: jar with ovoid body, rounded shoulders and convex base. Found on the south-eastern side of the sarcophagus, near AbT.13.183.2.

AbT.13.183.4 - Fig. 7.35

Dimensions: rim diam.: 7.5 cm; rim th.: 0.6 cm; wall th.: 0.9 cm; base diam.: 3.5 cm; base th.: 1 cm; h.: 6.6 cm.

Clay: outer colour: 7.5YR 4/3 (brown); inner and fabric colour: 7.5YR 6/4 (light brown); sand inclusions; medium-low firing temperature.

Description: small beaker. Found inside AbT.13.183.3.

AbT.13.183.5 - Fig. 7.36

Dimensions: rim diam.: 10 cm; rim th.: 0.4 cm; wall th.: 0.6 cm; base diam.: 7 cm; base th.: 0.5 cm; h.: 22.6 cm.

Clay: outer colour: 2.5Y 8/2 (pale brown); inner colour: 5YR 6/4 (light reddish brown); fabric colour: 5YR 5/4 (reddish brown); sand inclusions; medium-low firing temperature.

Description: plain rim jar. Found on the eastern side of the sarcophagus, near AbT.13.183.3.

AbT.13.183.6 - Fig. 7.35

Dimensions: rim diam.: 11 cm; rim th.: 0.5 cm; wall th.: 1 cm; base diam.: 5.5 cm; base th.: 1.5 cm; h.: 13.3 cm.

Clay: outer colour: 5YR 5/6 (yellowish red); inner colour: 5YR 6/4 (light reddish brown); sand inclusions; medium-low firing temperature.

Description: beaker. Found on the east side of the sarcophagus.

AbT.13.183.7 - Fig. 7.36

Dimensions: rim diam.: 9 cm; rim th.: 0.4 cm; wall th.: 0.5 cm; base diam.: 5.5 cm; base th.: 0.3 cm; h.: 21.4 cm.

Clay: outer colour: 7.5YR 8/2 (pinkish white); inner colour: 5YR 7/6 (reddish yellow); fabric colour: 5YR 4/3 (reddish brown); sand inclusions; medium firing temperature.

Description: plain rim jar. Found on the eastern side of the sarcophagus.

AbT.13.183.8 - Fig. 7.35

Dimensions: rim diam.: 12 cm; rim th.: 0.7 cm; wall th.: 0.8 cm; base diam.: 5 cm; base th.: 0.6 cm; h.: 13.6 cm.

Clay: outer and inner colour: 10YR 6/4 (light yellowish brown); sand inclusions; medium firing temperature. Description: beaker. Found on the eastern side of the sarcophagus.

AbT.13.183.9 - Fig. 7.36

Dimensions: rim th.: 0.7 cm; wall th.: 0.6 cm; base diam.: 10.5 cm; base th.: 0.5 cm; h.: 28 cm.

Clay: outer colour ("reserved-slip like" effect): 10YR 8/2 (very pale brown); inner colour: 7.5YR 7/3 (pink); fabric colour: 7.5YR 7/6 (reddish yellow); sand inclusions; medium-low firing temperature.

Description: jar with high neck, rounded shoulders, globular body and rounded base. Found on the north-eastern side of the sarcophagus.

AbT.13.183.10 - Fig. 7.35

Dimensions: rim diam.: 15 cm; rim th.: 0.6 cm; wall th.: 0.7 cm; base diam.: 5 cm; base th.: 0.8 cm; h.: 7.1 cm.

Clay: outer colour: 2.5YR 6/4 (light yellowish brown); inner colour: 5YR 5/4 (reddish brown); fabric colour: 5YR 7/6 (reddish yellow); sand inclusions; medium-low firing temperature.

Description: conical bowl. Found on the north-eastern side of the sarcophagus, near AbT.13.183.11 and AbT.13.183.12.

AbT.13.183.11 - Fig. 7.35

Dimensions: rim diam.: 14.5 cm; rim th.: 0.6 cm; wall th.: 0.8 cm; base diam.: 5.3 cm; base th.: 1.2 cm; h.: 8.7 cm.

Clay: outer colour: 7.5YR 6/4 (light brown); inner and fabric colour: 10YR 5/4 (yellowish brown); sand inclusions; medium-low firing temperature.

Description: conical bowl. Found on the north-eastern side of the sarcophagus, near AbT.13.183.10 and AbT.13.183.12.

AbT.13.183.12 - Fig. 7.36

Dimensions: rim diam.: 9.6 cm; rim th.: 0.4 cm; wall th.: 0.5 cm; base diam.: 5.2 cm; base th.: 0.4 cm; h.: 22.5 cm.

Clay: outer colour (self-slip): 2.5Y 8/2 (pale brown); inner colour: 5YR 5/4 (reddish brown); sand inclusions; medium-low firing temperature.

Description: plain rim of a jar with slightly convex base. Found on the north-eastern side of the sarcophagus, near AbT.13.183.10 and AbT.13.183.11.

AbT.13.183.13 - Fig. 7.36

Dimensions: wall th.: 0.8 cm; base diam.: 9 cm ca.; base th.: 1 cm.

Clay: outer colour (“reserved-slip like” effect): 2.5Y 7/3 (pale brown); inner colour: 7.5YR 6/4 (light brown); fabric colour: 7.5YR 5/4 (reddish brown); sand inclusions; medium firing temperature.

Description: jar with ovoid body, rounded shoulders and rounded base. Found on the northern side of the sarcophagus, near AbT.13.183.14.

AbT.13.183.14 - Fig. 7.35

Dimensions: rim diam.: 15 cm; rim th.: 0.6 cm; wall th.: 0.8 cm; base diam.: 5.5 cm; base th.: 0.7 cm; h.: 7.5 cm.

Clay: outer colour: 2.5Y 8/2 (pale brown); inner colour: 5YR 7/6 (reddish yellow); fabric colour: 7.5YR 5/6 (strong brown); sand inclusions; medium-low firing temperature.

Description: conical bowl. Found on the northern side of the sarcophagus, near AbT.13.183.13, AbT.13.183.15 and AbT.13.183.16.

AbT.13.183.15 - Fig. 7.35

Dimensions: rim diam.: 14.5 cm; rim th.: 0.6 cm; wall th.: 0.7 cm; base diam.: 5.5 cm; base th.: 0.8 cm; h.: 7 cm.

Clay: outer colour: 5YR 5/4 (reddish brown); inner colour: 7.5YR 8/3 (pink); fabric colour: 7.5YR 4/4 (brown); sand inclusions; low firing temperature.

Description: conical bowl. Found on the northern side of the sarcophagus, near AbT.13.183.13, AbT.13.183.14 and AbT.13.183.16.

AbT.13.183.16 - Fig. 7.35

Dimensions: rim diam.: 15.5 cm; rim th.: 0.7 cm; wall th.: 0.8 cm; base diam.: 5.2 cm; base th.: 1.3 cm; h.: 8 cm.

Clay: outer and fabric colour: 7.5YR 6/6 (reddish yellow); inner colour: 7.5YR 5/6 (strong brown); sand inclusions; medium-high firing temperature.

Description: conical bowl. Found on the northern side of the sarcophagus, near AbT.13.183.15 and AbT.13.183.14.

AbT.13.183.17 - Fig. 7.35

Dimensions: rim diam.: 14.2 cm; rim

th.: 0.7 cm; wall th.: 0.8 cm; base diam.: 6 cm; base th.: 1 cm; h.: 6.7 cm.

Clay: outer colour: 2.5Y 8/2 (pale brown); inner colour: 7.5YR 4/6 (strong brown); fabric colour: 7.5YR 6/4 (light brown); sand inclusions; medium-low firing temperature.

Description: conical bowl. Found on the southern side of the sarcophagus with AbT.13.183.1.

AbT.13.183.18 - Fig. 7.35

Dimensions: wall th.: 0.9 cm; base diam.: 5 cm; base th.: 1.5 cm.

Clay: outer, inner and fabric colour: 7.5YR 4/4 (brown); sand inclusions; medium-low firing temperature.

Description: conical bowl base. Found between AbT.13.183.2 and AbT.13.183.3.

AbT.13.183.19 - Fig. 7.35

Dimensions: rim diam.: 34 cm; rim th.: 1.7 cm; wall th.: 1 cm.

Clay: outer and inner colour: 7.5YR 6/4 (light yellowish brown); fabric colour: 7.5YR 5/6 (strong brown); sand inclusions; medium-high firing temperature.

Description: shallow upper bowl of a fruitstand with a wide notched rim with a single wavy groove on the top and a well defined, sharply notched ridge below.

AbT.13.183.20 - Fig. 7.35

Dimensions: rim diam.: 30 cm; rim th.: 1.8 cm; wall th.: 1 cm.

Clay: outer colour (self-slip): 2.5Y 8/2 (pale brown); inner and fabric colour: 7.5YR 5/4 (brown); sand inclusions; medium-low firing temperature.

Description: triangular rim bowl.

AbT.13.183.21+22 - Fig. 7.35

Dimensions: rim diam.: 28 cm; rim th.: 2 cm; wall th.: 0.9 cm.

Clay: outer colour: 7.5YR 8/1 (white); inner colour: 7.5YR 8/3 (pink); fabric colour: 7.5YR 6/6 (reddish yellow); sand inclusions; medium firing temperature.

Description: triangular rim bowl. Probably same vessel of AbT.13.183.22.

AbT.13.183.23 - Fig. 7.36

Dimensions: rim diam.: 14 cm; rim th.: 0.7 cm; wall th.: 0.8 cm.

Clay: outer and inner colour: 5Y 8/2 (pale yellow); fabric colour: 7.5YR 6/4

(light brown); sand inclusions; medium firing temperature.

Description: plain rim jar.

AbT.13.183.24 - Fig. 7.36

Dimensions: rim diam.: 15.6 cm; rim th.: 0.6 cm; wall th.: 0.6 cm.

Clay: outer and inner colour: 5Y 8/3 (pale yellow); fabric colour: 5Y 7/3 (pale yellow); sand inclusions; medium firing temperature.

Description: plain rim jar.

AbT.13.183.25 - Fig. 7.36

Dimensions: rim diam.: 16 cm; rim th.: 1.4 cm; wall th.: 0.8 cm.

Clay: outer colour: 5Y 7/3 (pale yellow); inner colour: 2.5Y 8/2 (pale brown); fabric colour: 2.5Y 6/3 (light yellowish brown); sand inclusions; medium firing temperature.

Description: triangular rim jar.

AbT.13.183.26 - Fig. 7.36

Dimensions: rim diam.: 14 cm; rim th.: 0.8 cm; wall th.: 0.7 cm.

Clay: outer and inner colour: 2.5Y 8/2 (pale brown); fabric colour: 10YR 6/4 (light yellowish brown); sand inclusions; medium firing temperature.

Description: double-ridged rim jar.

AbT.13.183.27 - Fig. 7.36

Dimensions: rim diam.: 14 cm; rim th.: 0.9 cm.

Clay: outer and inner colour: 2.5Y 8/3 (pale brown); fabric colour: 2.5Y 6/4 (light yellowish brown); sand inclusions; medium firing temperature.

Description: band rim jar.

AbT.13.183.28 - Fig. 7.36

Dimensions: wall th.: 1.9-2.3 cm; width.: 6.5 cm.

Clay: outer and inner colour: 5Y 7/3 (pale yellow); fabric colour: 5YR 4/6 (yellowish red); sand and vegetal inclusions; medium-high firing temperature.

Description: coarse handle.

AbT.13.183.29 - Fig. 7.35

Dimensions: wall th.: 0.7 cm.

Clay: outer, inner and fabric colour: 10YR 7/4 (very pale brown); sand inclusions; medium-high firing temperature.

Description: wall fragment with incised hatched triangles.

AbT.13.183.30 - Fig. 7.35

Dimensions: wall th.: 0.7-1 cm.

Clay: outer and inner colour: 2.5Y 7/3 (pale brown); fabric colour: 10YR 6/4 (light yellowish brown); sand inclusions; medium-low firing temperature.

Description: wall fragment with notched ridge.

AbT.13.183.31 - Fig. 7.36

Dimensions: wall th.: 0.7 cm; base diam.: 11 cm; base th.: 0.7 cm.

Clay: outer colour: 10YR 8/2 (very pale brown); inner colour: 2.5Y 7/4 (pale brown); fabric colour: 7.5YR 6/6 (reddish yellow); sand inclusions; medium-low firing temperature.

Description: base with two (of three) pinched feet.

AbT.13.183.32 - Fig. 7.36

Dimensions: wall th.: 0.9 cm; base diam.: 7 cm; base th.: 0.7 cm.

Clay: outer colour: 7.5YR 6/4 (light brown); inner colour: 10YR 6/4 (light yellowish brown); fabric colour: 10YR 4/4 (dark yellowish brown); sand inclusions; medium-high firing temperature.

Description: ring base.

AbT.13.183.33 - Fig. 7.36

Dimensions: base diam.: 34 cm; base th.: 2.5 cm.

Clay: outer, inner and fabric colour: 7.5YR 6/6 (reddish yellow); sand and vegetal inclusions; medium firing temperature.

Description: ring base.

Catalogue of US 184 Finds

*Pottery***AbT.13.184.1 - Fig. 7.32**

Dimensions: rim diam.(min): 90 cm ca.; rim th.: 4 cm; wall th.: 2 cm; base diam.: 70 cm; base th.: 2 cm; h.: 37 cm.

Clay: outer, inner and fabric colour: 10YR 6/4 (light yellowish brown); sand and vegetal inclusions; medium firing temperature.

Description: Scoiled coffin with flat base and two ridges on the wall.

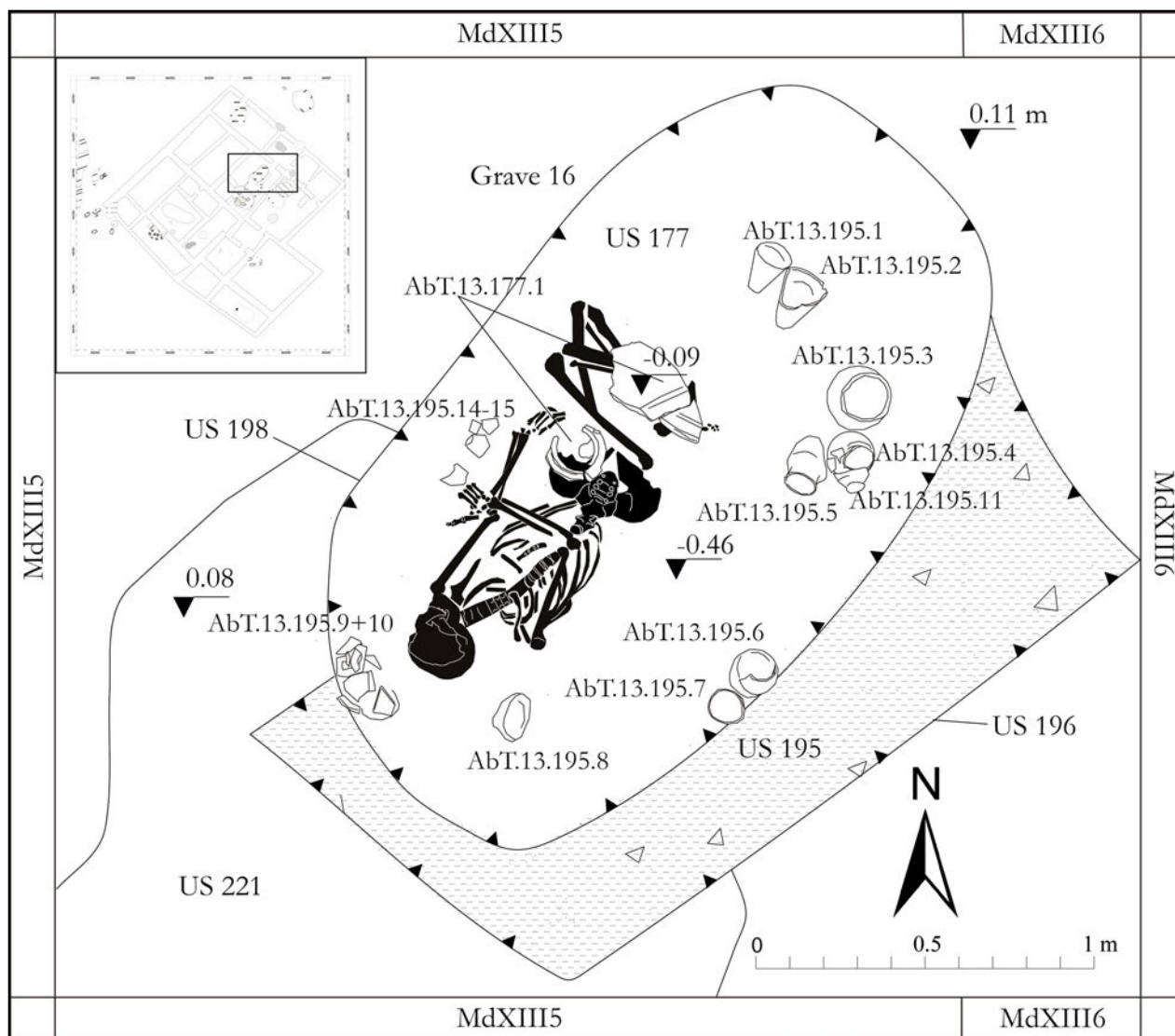

Fig. 7.37 Grave 16 plan.

7.2.2 GRAVE 16 [LR]

Grave 16 was located in MdXIII5-6 (Figs 7.37-7.41).²² Immediately under the surface (elevation 0.11 m), the presence in the area of some subsequent activities was visible: a rectangular pit (US 196) was filled by a friable ashy and greyish soil (US 195) and was cut by a second oval pit (US 198), filled by a quite soft, yellowish brown, and silty soil (US 177). A great amount of pottery was collected from US 177, including several fragments of a stemmed-dish (AbT.13.177.1; Fig. 7.40).²³ On the bottom of the cut (elevation -0.46

m) the skeleton (US 197 - Fig. 7.39) was laying in a semi-flexed position, on the left side, with the head toward south-west, looking northward and the right arm flexed over the torax.²⁴ The legs were bent toward north with the feet placed at north-east. The pottery equipment surrounding the skeleton (elevation -0.41 m) followed the limits of the cut US 198. At the beginning we thought that the rectangular pit US 197 was the original

and 10.41 *sub e*), rims of at least 5 different bowls, several plain rims of jars, 6 flat bases of jars, 6 convex bases of jars, 3 bases with pinched feet, 6 ring bases. Some pieces of the stemmed-dish AbT.13.177.1 have been found in correspondence of the skeleton lower part but at a higher elevation (-0.09 m).

²⁴ The right hand was apparently holding something (one of the conical bowls discovered nearby?).

²² For the grave see: D'Agostino *et al.* 2015: 212; 2016: 48.

²³ In addition to the chariot model and the pottery fragments in the catalogue, the following pieces were found: at least 25 drinking vessels bases, a fragment of a strainer, 1 upturned rim of a bowl, 1 black(?) burnished flared rim (see § 10.4.2

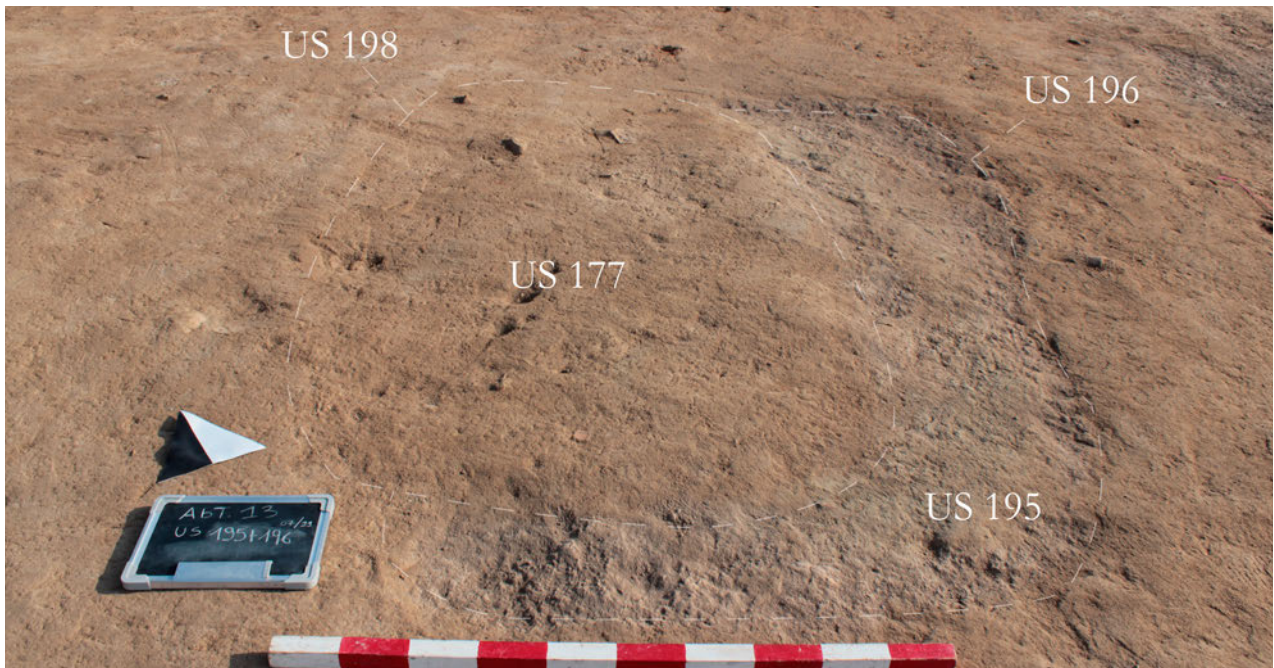

Fig. 7.38 Grave 16 before excavation.



Fig. 7.39 Grave 16.



Fig. 7.40 AbT.13.177.1 during the excavation.



Fig. 7.41 Grave 16 equipment (US 177+195).

cut of the grave²⁵ and thus we assigned to the equipment and to the pit's backfill the same US number.²⁶ However it is probable that the original limits of the grave, that seems untouched by later activities,²⁷ were those of the cut US 198: thus US 195 and US 198 should be interpreted as separated activities, being US 195-196 another dump pit or, possibly, a previous inhumation.²⁸

As far as the position of the equipment is concerned, a beaker was located near the head, 3 other conical bowl bases near the right hand and another one behind the head. Northward, near the feet, two beakers were discovered, and at north-east of the body other vessels were deposited in two small clusters: the southernmost was formed by a beaker and a jar, the other by two jars, one covered by a bowl used as a lid, and a trumpet base jar.



Fig. 7.42 US 177 objects.

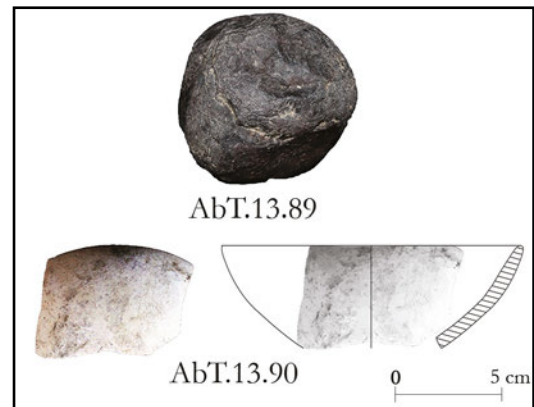

Fig. 7.43 US 195 objects.

²⁵ D'Agostino *et al.* 2015: 212.

²⁶ The catalogue numbers from AbT.13.195.1 to 14 are part of the equipment. The others belong to the grayish soil US 195.

²⁷ The skeleton was in connection and the equipment was apparently entirely preserved. The fragments of the stemmed dish and of the other pottery shapes discovered scattered in the backfill during the excavation of US 177 could be thus in secondary deposition and we cannot attribute this fragments to the activities connected with the deposition. The two finds AbT.13.89 and AbT.13.90 are not connected to the grave equipment.

²⁸ The discovery of some human remains in the filling (see §§ 13.1.15 and 19) might indicate the presence of a previous burial, destroyed by Grave 16. The decorated stemmed-dish, a typical ED III grave good, might thus belong to the earlier grave.

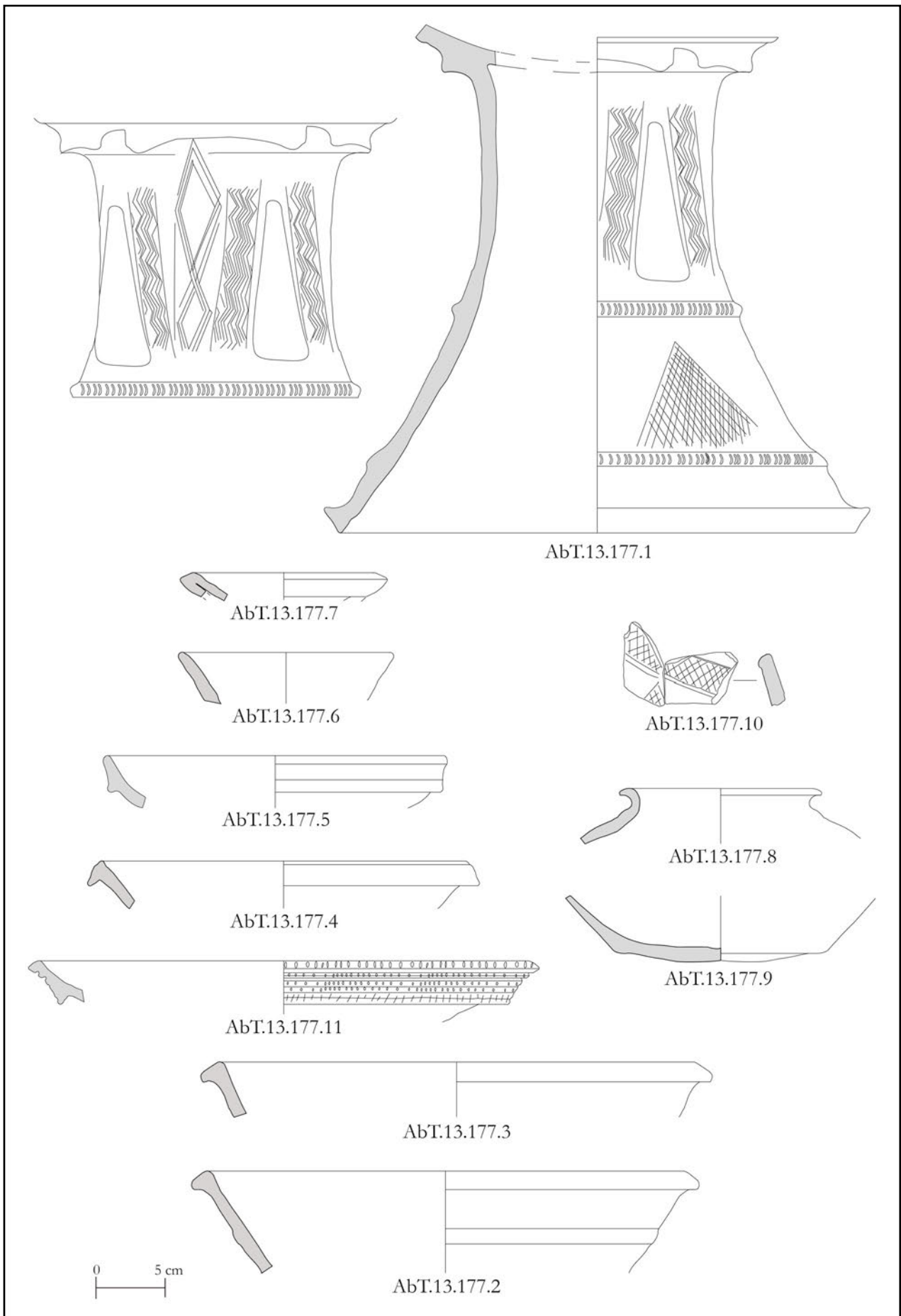

Fig. 7.44 US 177 pottery.

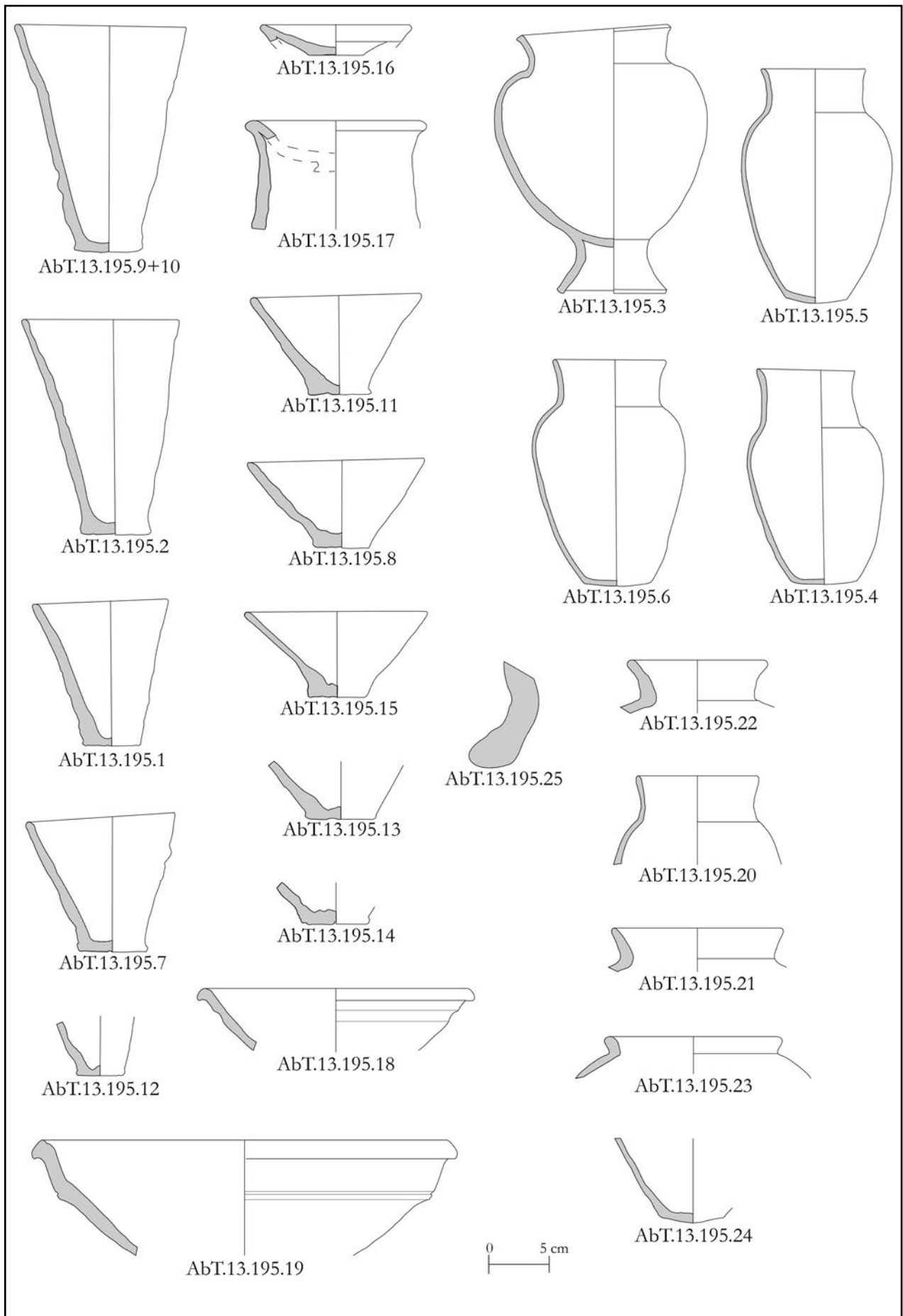

Fig. 7.45 US 195 pottery.

Catalogue of US 177 Finds

*Objects***AbT.13.86 - Fig. 7.42**

Description: two-wheel chariot model pierced on the bottom and on the vertical part.

Dimensions: 6.4x8.4x7.5 cm.

*Pottery***AbT.13.177.1 - Fig. 7.44**

Dimensions: wall th.: 0.9 cm; base diam.: 36.8 cm; base th.: 1.8 cm.

Clay: outer colour (self-slip?): 10YR 6/4 (light yellowish brown); inner and fabric colour: 7.5YR 4/4 (brown); sand inclusions; medium-low firing temperature.

Description: stemmed-dish with incised decoration. Three long triangular openings on the stem, flanked by a pair of two oblique lines filled by a herringbone pattern. The intervening space between the openings contains one and half superimposed lozenge, made with a three incisions series, ending in a small triangle with hatched motif. Two applied notched ridges (below the openings and near the base). Between the ridges, six large incised triangles filled with hatched pattern. Found in fragments and restored.

AbT.13.177.2 - Fig. 7.44

Dimensions: rim diam.: 34 cm; rim th.: 1.9 cm; wall th.: 1 cm.

Clay: outer and inner colour: 2.5Y 7/4 (pale brown); fabric colour: 5YR 4/6 (yellowish red); sand inclusions; medium firing temperature.

Description: triangular rim bowl.

AbT.13.177.3 - Fig. 7.44

Dimensions: rim diam.: 34 cm; rim th.: 2.1 cm; wall th.: 1.1 cm.

Clay: outer colour: 2.5Y 7/4 (pale brown); inner colour: 10YR 7/4 (very pale brown); fabric colour: 5YR 4/6 (yellowish red); sand inclusions; medium firing temperature.

Description: triangular rim bowl.

AbT.13.177.4 - Fig. 7.44

Dimensions: rim diam.: 26 cm; rim th.: 2.1 cm; wall th.: 0.9 cm.

Clay: outer colour: 10YR 7/3 (very pale brown); inner and fabric colour: 10YR 6/4 (light yellowish brown); sand

inclusions; medium firing temperature.

Description: triangular rim bowl.

Groove or depression on the rim.

AbT.13.177.5 - Fig. 7.44

Dimensions: rim diam.: 24 cm; rim th.: 1.6 cm; wall th.: 1 cm.

Clay: outer and inner colour: 7.5YR 6/4 (light brown); fabric colour: 5YR 4/4 (reddish brown); sand inclusions; medium-high firing temperature.

Description: band rim bowl (of a stemmed-dish?).

AbT.13.177.6 - Fig. 7.44

Dimensions: rim diam.: 14.8 cm; rim th.: 0.7 cm; wall th.: 1 cm.

Clay: outer colour and inner (black polished): 10YR 3/1 (very dark grey); fabric colour: 2.5Y 4/1 (dark grey); sand inclusions; medium firing temperature.

Description: drinking vessel rim.

AbT.13.177.7 - Fig. 7.44

Dimensions: rim diam.: 13 cm; rim th.: 1.2 cm; wall th.: 0.6 cm.

Clay: outer, inner and fabric colour: 5YR 5/6 (yellowish red); sand inclusions; medium-low firing temperature.

Description: misshapen rim of a bowl (attached to a stem?).

AbT.13.177.8 - Fig. 7.44

Dimensions: rim diam.: 13 cm; rim th.: 1.2 cm; wall th.: 1.1 cm.

Clay: outer colour: 10YR 6/4 (light yellowish brown); inner and fabric colour: 5YR 5/6 (yellowish red); sand inclusions; medium firing temperature.

Description: triangular rim jar.

AbT.13.177.9 - Fig. 7.44

Dimensions: wall th.: 0.8 cm; base diam.: 13 cm; base th.: 0.8 cm.

Clay: outer, inner and fabric colour: 5Y 7/3 (pale yellow); sand inclusions; medium firing temperature.

Description: convex base.

AbT.13.177.10 - Fig. 7.44

Dimensions: wall th.: 0.8 cm.

Clay: outer and inner colour: 7.5YR 5/6 (strong brown); fabric colour: 7.5YR 4/4 (brown); sand inclusions; medium-low firing temperature.

Description: decorated fragment of a jar shoulder. Register created by two couple of incised lines. The central

part of the register is decorated with a hatched pattern.

AbT.13.177.11 - Fig. 7.44

Dimensions: rim diam.: 35 cm; rim th.: 1.1 cm; wall th.: 1.3 cm.

Clay: outer colour: 7.5YR 8/2 (pinkish white); inner colour and fabric colour: 5YR 7/4 (pink); sand inclusions; medium-high firing temperature.

Description: stemmed-dish band rim with an incised grid-like decoration.

Catalogue of US 195 Finds

*Objects***AbT.13.89 - Fig. 7.43**

Description: stone tool. All faces of the polyhedron show light traces of pounding. Several surfaces present polishing signs, but only two were markedly used for polishing activities. [SC]

Dimensions: 7x7.1x7.8 cm.

AbT.13.90 - Fig. 7.43

Description: alabaster bowl fragment.

Dimensions: 0.4x0.6x14 cm.

*Pottery***AbT.13.195.1 - Fig. 7.45**

Dimensions: rim diam.: 11.3 cm; rim th.: 0.7 cm; wall th.: 1.2 cm; base diam.: 5.2 cm; base th.: 0.8 cm; h.: 12.9 cm.

Clay: outer, inner, fabric colour: 2.5Y 7/4 (pale brown); sand inclusions; medium-high firing temperature.

Description: beaker. Found on the north-eastern side of the skeleton, near AbT.13.195.2.

AbT.13.195.2 - Fig. 7.45

Dimensions: rim diam.: 13.3 cm; rim th.: 0.7 cm; wall th.: 1.3 cm; base diam.: 6.3 cm; base th.: 1 cm; h.: 18 cm.

Clay: outer colour: 2.5Y 8/2 (pale brown); inner colour: 5YR 6/6 (reddish yellow); fabric colour: 5YR 5/4 (reddish brown); sand inclusions; medium firing temperature.

Description: beaker. Found on the north-eastern side of the skeleton, near AbT.13.195.1.

AbT.13.195.3 - Fig. 7.45

Dimensions: rim diam.: 13 cm; rim th.: 0.7 cm; wall th.: 1 cm; base diam.: 8.7

cm; base th.: 0.7 cm; h.: 22 cm.
Clay: outer, inner, fabric colour: 5Y 7/3 (pale yellow); sand inclusions; medium-high firing temperature.

Description: trumpet base jar. Found on the eastern side of the skeleton, near AbT.13.195.4, AbT.13.195.5 and AbT.13.195.11.

AbT.13.195.4 - Fig. 7.45

Dimensions: rim diam.: 9 cm; rim th.: 0.5 cm; wall th.: 0.6 cm; base diam.: 5.7 cm; base th.: 0.5 cm; h.: 18. cm.

Clay: outer, inner and fabric colour: 2.5Y 8/3 (pale brown); sand inclusions; medium-high firing temperature.

Description: plain rim jar. Found on the eastern side of the skeleton, near AbT.13.195.3, AbT.13.195.5 and AbT.13.195.11.

AbT.13.195.5 - Fig. 7.45

Dimensions: rim diam.: 9.1 cm; rim th.: 0.5 cm; wall th.: 0.6 cm; base diam.: 5.4 cm; base th.: 0.6 cm; h.: 19.6 cm.

Clay: outer, inner and fabric colour: 2.5Y 8/4 (pale brown); sand inclusions; medium-high firing temperature.

Description: plain jar. Found on the eastern side of the skeleton, near AbT.13.195.3, AbT.13.195.4 and AbT.13.195.11.

AbT.13.195.6 - Fig. 7.45

Dimensions: rim diam.: 9.6 cm; rim th.: 0.45 cm; wall th.: 0.6 cm; base diam.: 5.7 cm; base th.: 0.5 cm; h.: 19 cm.

Clay: outer (self-slip) and inner colour: 2.5Y 8/2 (pale brown); fabric colour: 7.5YR 7/4 (pink); sand inclusions; medium firing temperature.

Description: plain rim jar. Found on the south-eastern side of the skeleton, near AbT.13.195.7. Burning traces?

AbT.13.195.7 - Fig. 7.45

Dimensions: rim diam.: 11 cm; rim th.: 0.7 cm; wall th.: 1.1 cm; base diam.: 5.9 cm; base th.: 0.9 cm; h.: 11.7 cm.

Clay: outer and inner colour: 7.5YR 8/2 (pinkish white); fabric colour: 7.5YR 7/4 (pink); sand inclusions; medium-low firing temperature.

Description: beaker. Found on the south-eastern side of skeleton, near AbT.13.195.6.

AbT.13.195.8 - Fig. 7.45

Dimensions: rim diam.: 14.2 cm; rim th.: 0.8 cm; wall th.: 0.8 cm; base diam.:

4.8 cm; base th.: 1.4 cm; h.: 7.5 cm.

Clay: outer colour: 7.5YR 8/2 (pinkish white); inner and fabric colour: 7.5YR 7/4 (pink); sand inclusions; medium-low firing temperature.

Description: conical bowl. Found on the southern side of the skeleton, near the skull.

AbT.13.195.9+10 - Fig. 7.45

Dimensions: rim diam.: 13.5 cm; rim th.: 0.7 cm; wall th.: 1.2 cm; base diam.: 5.4 cm; base th.: 1.1 cm; h.: 19.5 cm.

Clay: outer and inner colour: 7.5YR 8/2 (pinkish white); fabric colour: 7.5YR 6/4 (light brown); sand inclusions; medium-low firing temperature.

Description: beaker. Found on south-south-western side of the skeleton, near the skull.

AbT.13.195.11 - Fig. 7.45

Dimensions: rim diam.: 13.5 cm; rim th.: 0.7 cm; wall th.: 0.7 cm; base diam.: 5 cm; base th.: 0.7 cm; h.: 8.9 cm.

Clay: outer and inner colour: 7.5YR 8/2 (pinkish white); fabric colour: 7.5YR 6/4 (light brown); sand inclusions; medium-low firing temperature.

Description: conical bowl. Found on the eastern side of the skeleton, near AbT.13.195.3, AbT.13.195.4 and AbT.13.195.5.

AbT.13.195.12 - Fig. 7.45

Dimensions: wall th.: 0.8 cm; base diam.: 1.1 cm; base th.: 4 cm.

Clay: outer, inner and fabric colour: 7.5YR 7/4 (pink); sand inclusions; medium-high firing temperature.

Description: beaker base. Found on the western side of the skeleton, near the right hand together with AbT.13.195.13 and AbT.13.195.14.

AbT.13.195.13 - Fig. 7.45

Dimensions: wall th.: 0.7 cm; base diam.: 5.7 cm; base th.: 1 cm.

Clay: outer, inner and fabric colour: 7.5YR 6/4 (light brown); sand inclusions; medium-low firing temperature.

Description: conical bowl base. Found on the western side of the skeleton, near the right hand together with AbT.13.195.12 and AbT.13.195.14.

AbT.13.195.14 - Fig. 7.45

Dimensions: wall th.: 0.7 cm; base diam.: 5.4 cm; base th.: 1 cm.

Clay: outer colour: 7.5YR 7/3 (pink); inner colour: 7.5YR 8/2 (pinkish white); fabric colour: 7.5YR 6/4 (light brown); sand inclusions; medium-low firing temperature.

Description: conical bowl base. Found on the western side of the skeleton, near the right hand together with AbT.13.195.12 and AbT.13.195.13.

AbT.13.195.15 - Fig. 7.45

Dimensions: rim diam.: 15.4 cm; rim th.: 0.5 cm; wall th.: 0.8 cm; base diam.: 4.8 cm; base th.: 1.2 cm; h.: 7.4 cm.

Clay: outer colour: 7.5YR 6/6 (reddish yellow); inner colour: 2.5Y 7/4 (pale brown); fabric colour: 5YR 4/6 (yellowish red); sand inclusions; medium-low firing temperature.

Description: conical bowl.

AbT.13.195.16 - Fig. 7.45

Dimensions: rim diam.: 12 cm; rim th.: 1.4 cm; wall th.: 0.8 cm; base diam.: 4.6 cm; base th.: 0.6 cm; h.: 2 cm.

Clay: outer and fabric colour: 5YR 5/6 (yellowish red); inner colour: 10YR 8/3 (very pale brown); sand inclusions; medium firing temperature.

Description: conical bowl attached to a stand.

AbT.13.195.17 - Fig. 7.45

Dimensions: rim diam.: 14 cm; rim th.: 1.5 cm; wall th.: 1.1 cm.

Clay: outer, inner and fabric colour: 7.5YR 5/6 (strong brown); sand inclusions; medium-low firing temperature.

Description: conical bowl attached to a stand.

AbT.13.195.18 - Fig. 7.45

Dimensions: rim diam.: 22 cm; rim th.: 1.4 cm; wall th.: 0.9 cm.

Clay: outer and inner colour: 10YR 7/3 (very pale brown); fabric colour: 7.5YR 6/4 (light brown); sand inclusions; medium firing temperature.

Description: triangular rim bowl.

AbT.13.195.19 - Fig. 7.45

Dimensions: rim diam.: 34 cm ca.; rim th.: 1.7 cm; wall th.: 1.7 cm.

Clay: outer colour: 5YR 7/4 (pale yellow); inner colour: 5Y 5/4 (olive); fabric colour: 2.5Y 7/6 (yellow); sand inclusions; medium-high firing temperature.

Description: triangular rim bowl.

AbT.13.195.20 - Fig. 7.45

Dimensions: rim diam.: 10 cm; rim th.: 0.5 cm; wall th.: 0.5 cm.

Clay: outer and inner colour: 2.5Y 8/3 (pale brown); fabric colour: 10YR 8/4 (very pale brown); sand inclusions; medium-high firing temperature.

Description: plain rim jar.

AbT.13.195.21 - Fig. 7.45

Dimensions: rim diam.: 14 cm; rim th.: 0.6 cm; wall th.: 0.6 cm.

Clay: outer and inner colour: 5Y 8/3 (pale yellow); fabric colour: 10YR 6/4 (light yellowish brown); sand inclusions; medium firing temperature.

Description: plain rim jar.

AbT.13.195.22 - Fig. 7.45

Dimensions: rim diam.: 11 cm; rim th.: 0.8 cm; wall th.: 0.9 cm.

Clay: outer and inner colour: 2.5Y 8/3

(pale brown); fabric colour: 7.5YR 6/6 (reddish yellow); sand inclusions; medium firing temperature.

Description: plain rim jar.

AbT.13.195.23 - Fig. 7.45

Dimensions: rim diam.: 14 cm; rim th.: 1 cm; wall th.: 0.8 cm.

Clay: outer and inner colour (slip): 10YR 8/3 (very pale brown); fabric colour: 7.5YR 6/6 (reddish yellow); sand inclusions; medium firing temperature.

Description: plain rim jar.

AbT.13.195.24 - Fig. 7.45

Dimensions: wall th.: 0.8 cm; base diam.: 5.5 cm; base th.: 1.1 cm.

Clay: outer and inner colour: 2.5Y 8/3 (pale brown); fabric colour: 5YR 5/6 (yellowish red); sand inclusions;

medium-low firing temperature.

Description: convex base.

AbT.13.195.25 - Fig. 7.45

Dimensions: wall th.: 3.8 cm; base th.: 2.3 cm.

Clay: outer and inner colour: 5Y 5/3 (olive); fabric colour: 5Y 5/2 (olive grey); sand and vegetal inclusions; high firing temperature.

Description: ring base fragment.



Fig. 7.46 Upper part of the dump pit with the cut of Grave 15 visible.



Fig. 7.47 Spouted vessel and ring base found immediately under the bottom of Grave 15 coffin.

7.2.3 OTHER ACTIVITIES [LR]

Graves 15 and 16 were cut directly over a huge dump pit (filling US 221=242=255; cut US 241). The pit destroyed almost completely the filling of Room 7 (Figs 6.46-49).²⁹ The filling of the pit was identified at the elevation of -0.08 m. The silty-clay soil was mainly greenish-gray, with ashy lenses and organic black concretions, full of incrustated pottery fragments, bones, fishbones, shells and lithic objects. The upper part of the stratum was exposed to rainfalls after the 2013 excavations. A huge quantity of vessels were found in the pit, including at least 250 drinking vessels, 80 jars of different dimensions, and a variety of other shapes (braziers, stands, big coarse vats, trays, cylinders etc.). At the elevation of -0.25 m, along the margin of the pit, two burnt mud-bricks were found (US 255), deposited vertically. The soil between the two bricks was rich of organic material and pottery. Initially deemed as a sort of bench, with reeds or wood put over the bricks, US 255 was interpreted as part of the dump pit (US 241) on the basis of the absence of any connected groundsurface or other activity.

The presence of the pit was not immediately recognized. The diffused margins of the cut, the several layers forming the filling, and the later activities (Graves 15 and 16) made it impossible to clearly distinguish the actions

or phases of accumulation inside the pit. The highlighted situation, and the various steps in the interpretation of the context will be described. On the bottom of Grave 15 cut, a few centimeters under the coffin base, an almost entire spouted vessel (AbT.14.221.1), a big pierced jar base (AbT.14.221.3),³⁰ and still articulated equid bones (see § 13.1.15) were found (Fig. 7.47). Initially, these findings were attributed to a sort of offering, made before laying the sarcophagus of Grave 15. The stratum on which they were lying was the backfill of the dump pit (US 221). Consequently, it is not clear if the findings the top of the stratum belonged to the dump pit or to the grave (or to another disturbed context). Though the huge dump pit was identified, its unclear limits were revised several times during the excavation. The diffused margins were probably caused by several and subsequent sloping layers, not singularly identifiable due to the cuts of Grave 15 and 16.³¹ For these reasons the pottery from the layers filling Room 7 (US 239-238-176) cannot be considered reliable. At the same time, Grave 16 pottery (see above) cannot be considered reliable, with the exception of the complete vessels surrounding the body and indicated at Fig. 7.37.³²

²⁹ In Fig. 7.37 the position of the findings of US 221, 242 and 255 have been reported. They were interpreted as belonging to the dump pit but their location was made available for allowing eventual further interpretations of the context. The relative elevation of each find is reported under the inventory number.

³⁰ Fish bones were found in the soil contained and in direct connection with both vessels.

³¹ The pottery fragments recovered (at least from AbT.14.221.69) should be considered as belonging to the backfill of the pit under the elevation of -0.2 m.

³² The restored stemmed-dish AbT.13.177.1, for example, were found in pieces at several depths inside US 177 (see § 7.2.2).

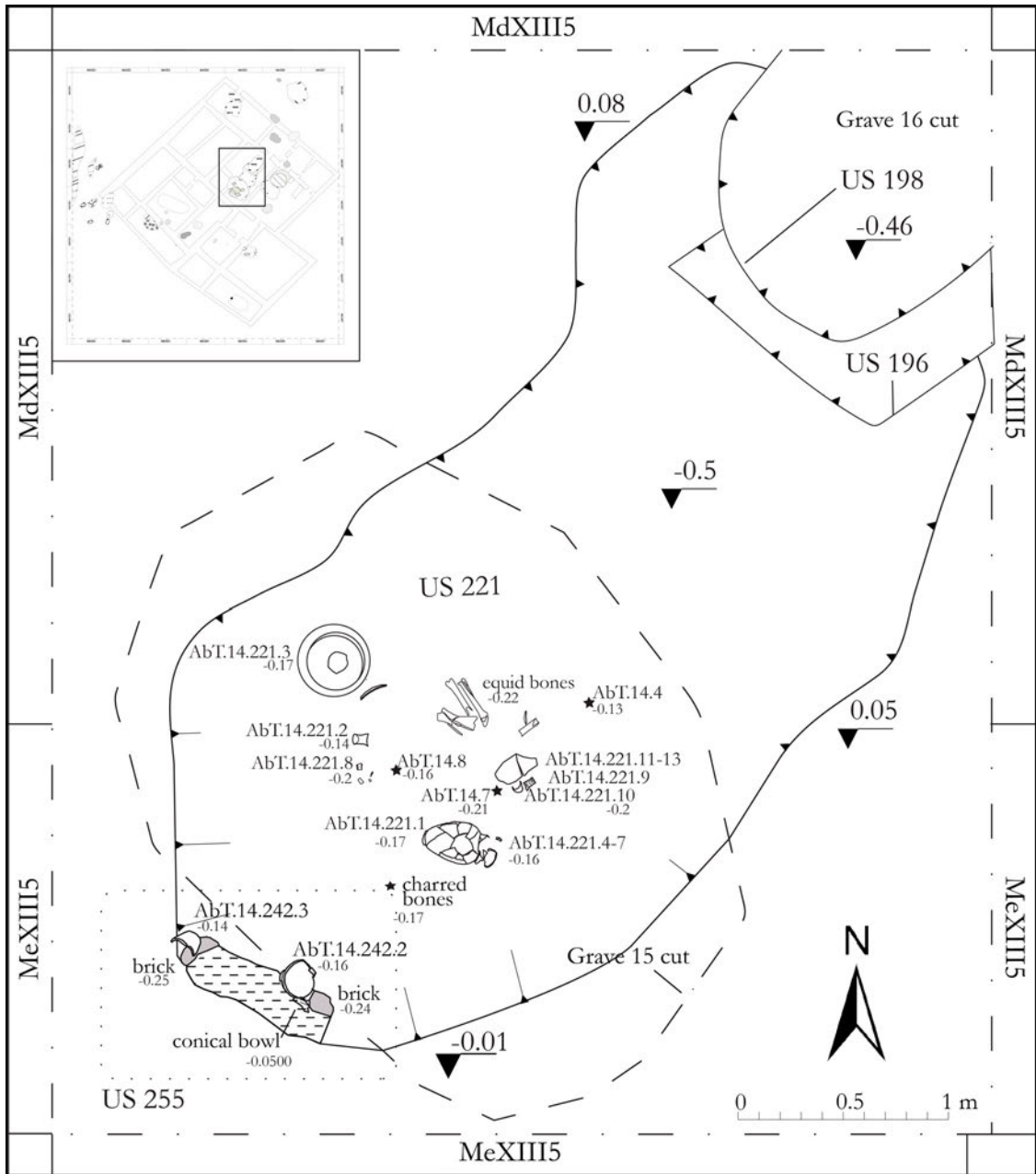

Fig. 7.48 Plan of the other activities in MdXIII5+6+MeXIII5 (dump pit).



Fig. 7.49 Dump pit and the Graves 15-16 cuts.

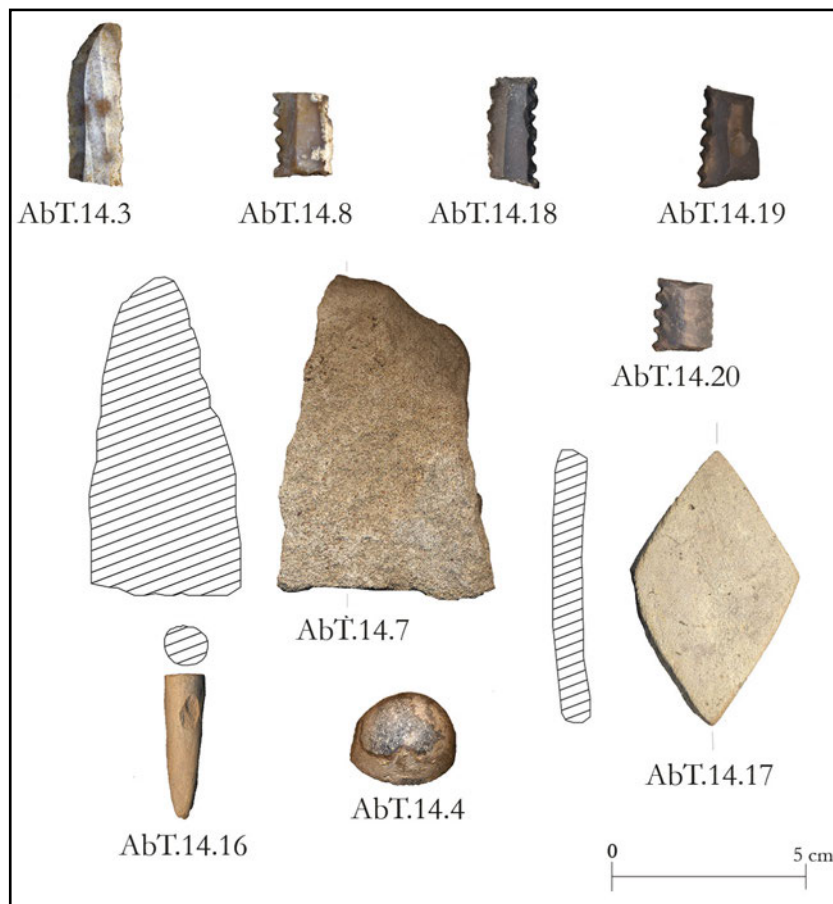

Fig. 7.50 US 221 objects.

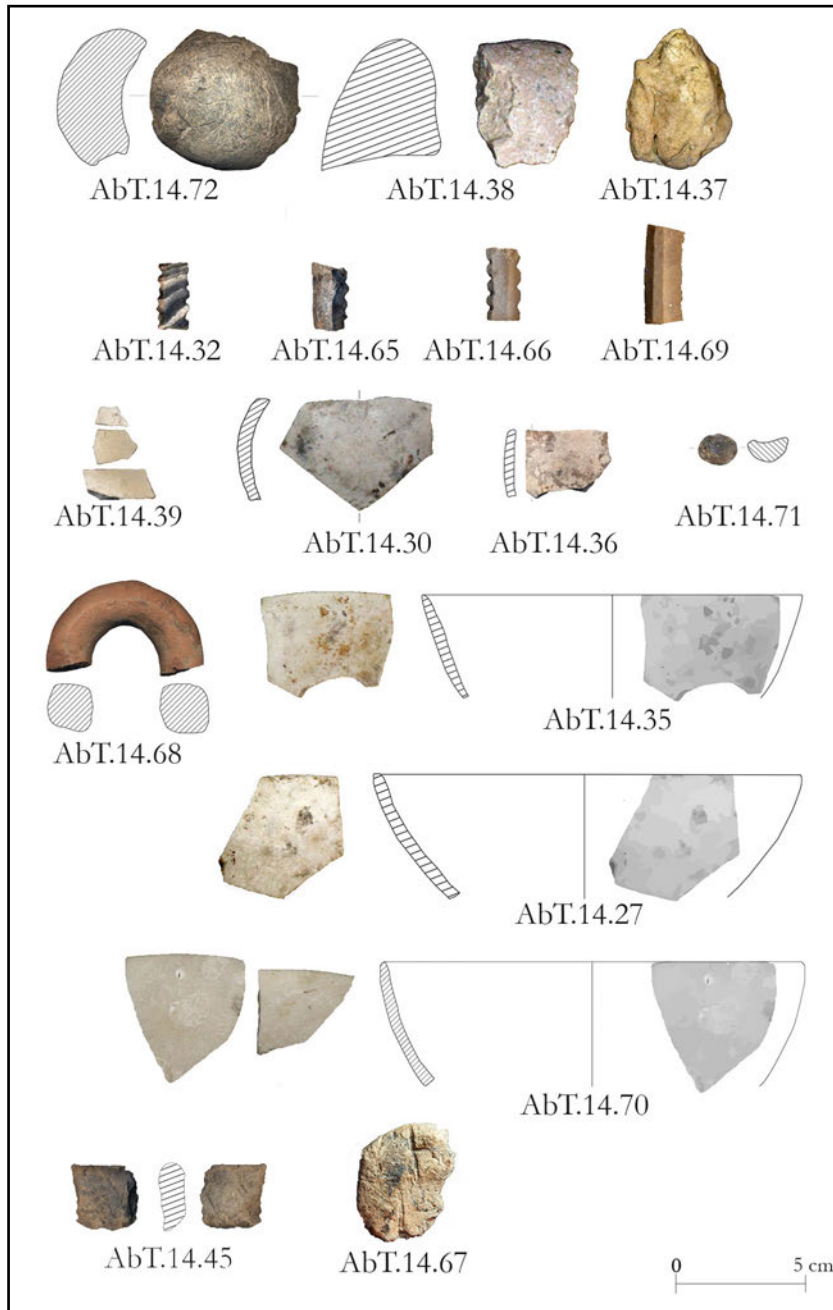

Fig. 7.51 US 242 objects.

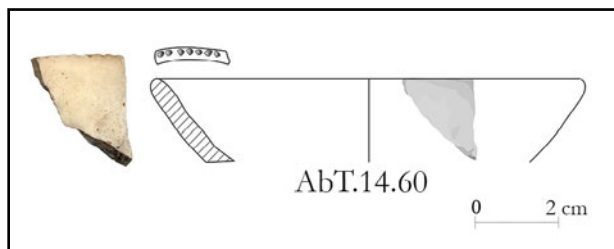

Fig. 7.52 US 255 objects.

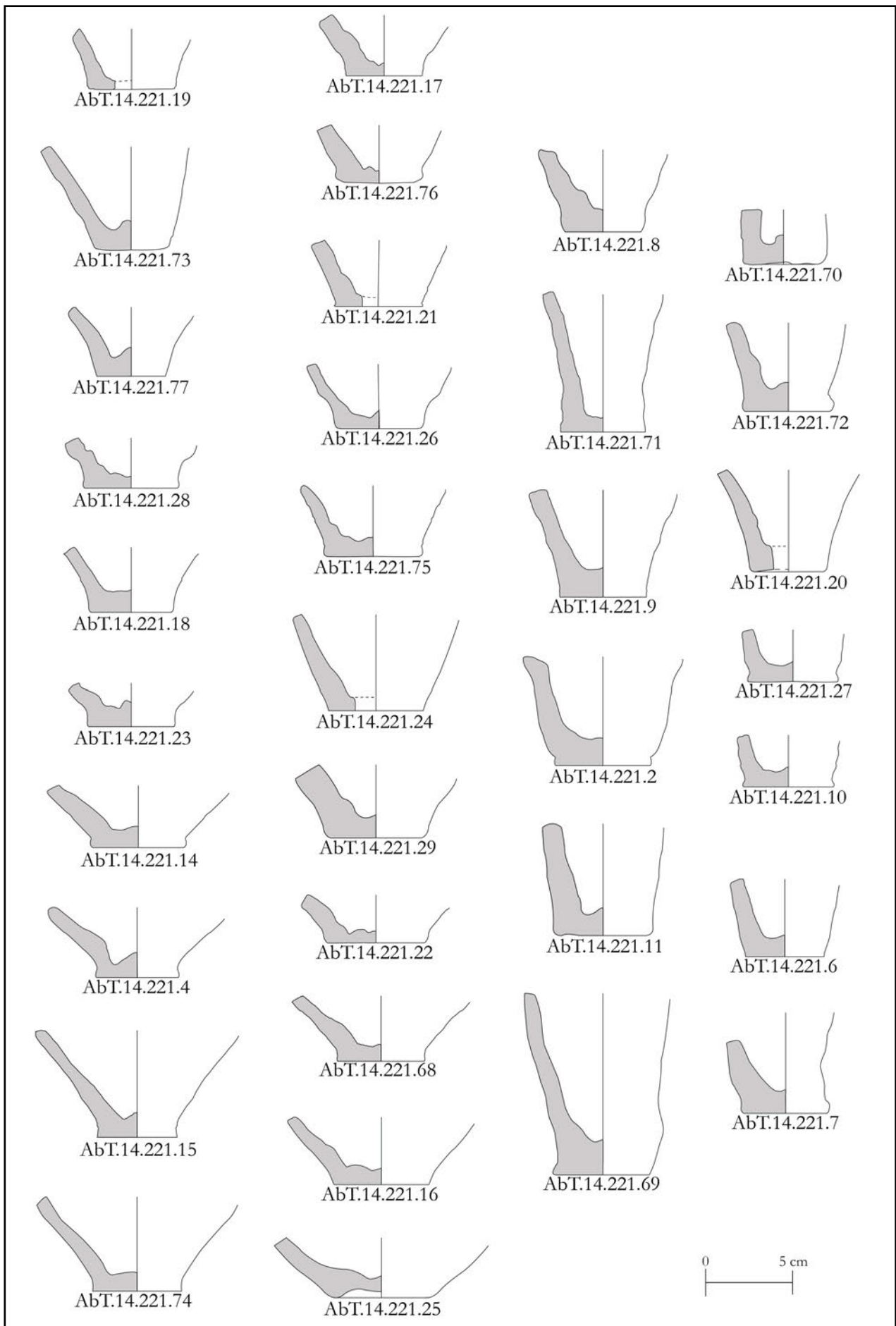

Fig. 7.53 US 221 pottery: open shapes (continues).

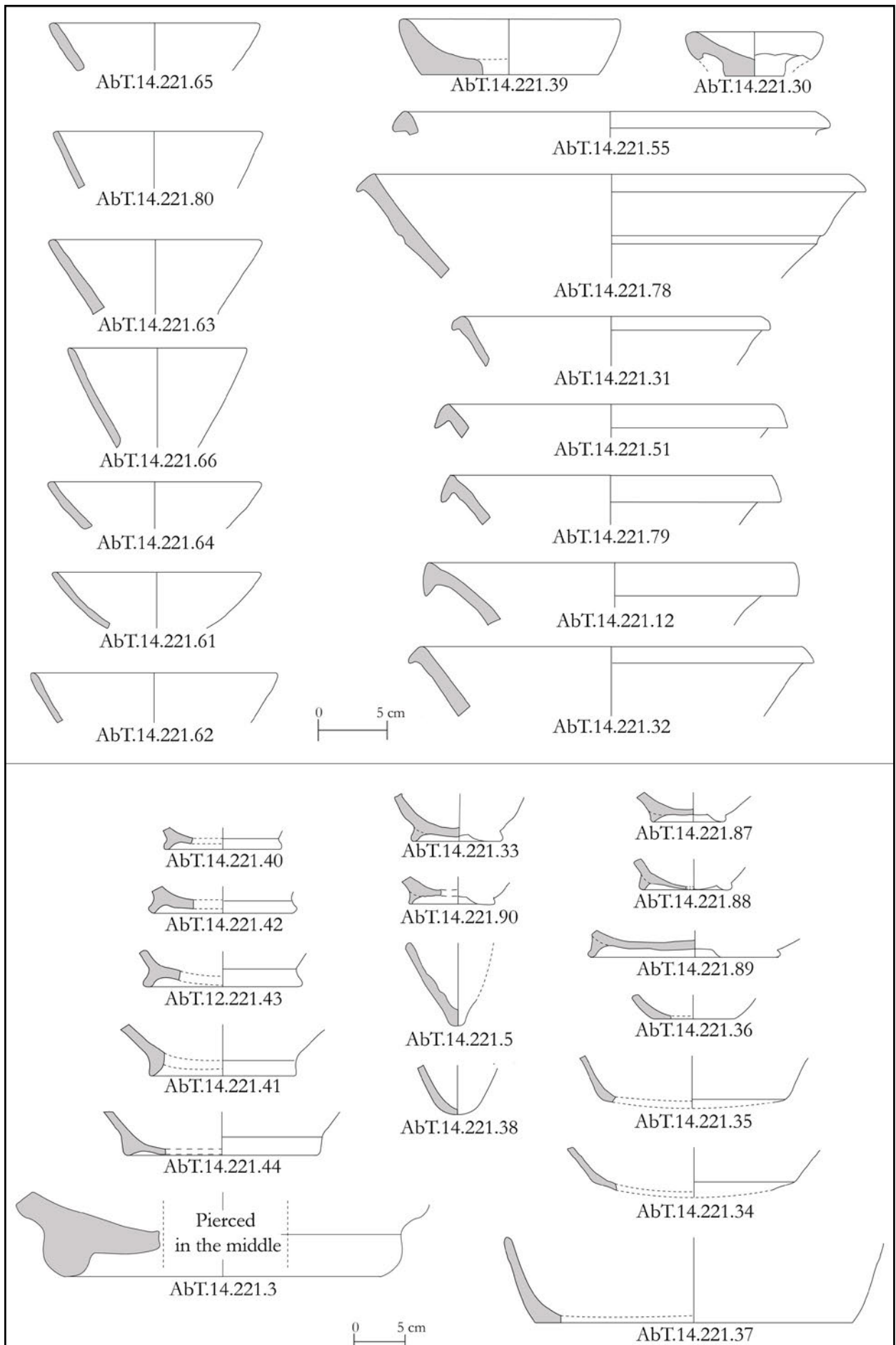

Fig. 7.54 US 221 pottery: open and closed shapes (continues).

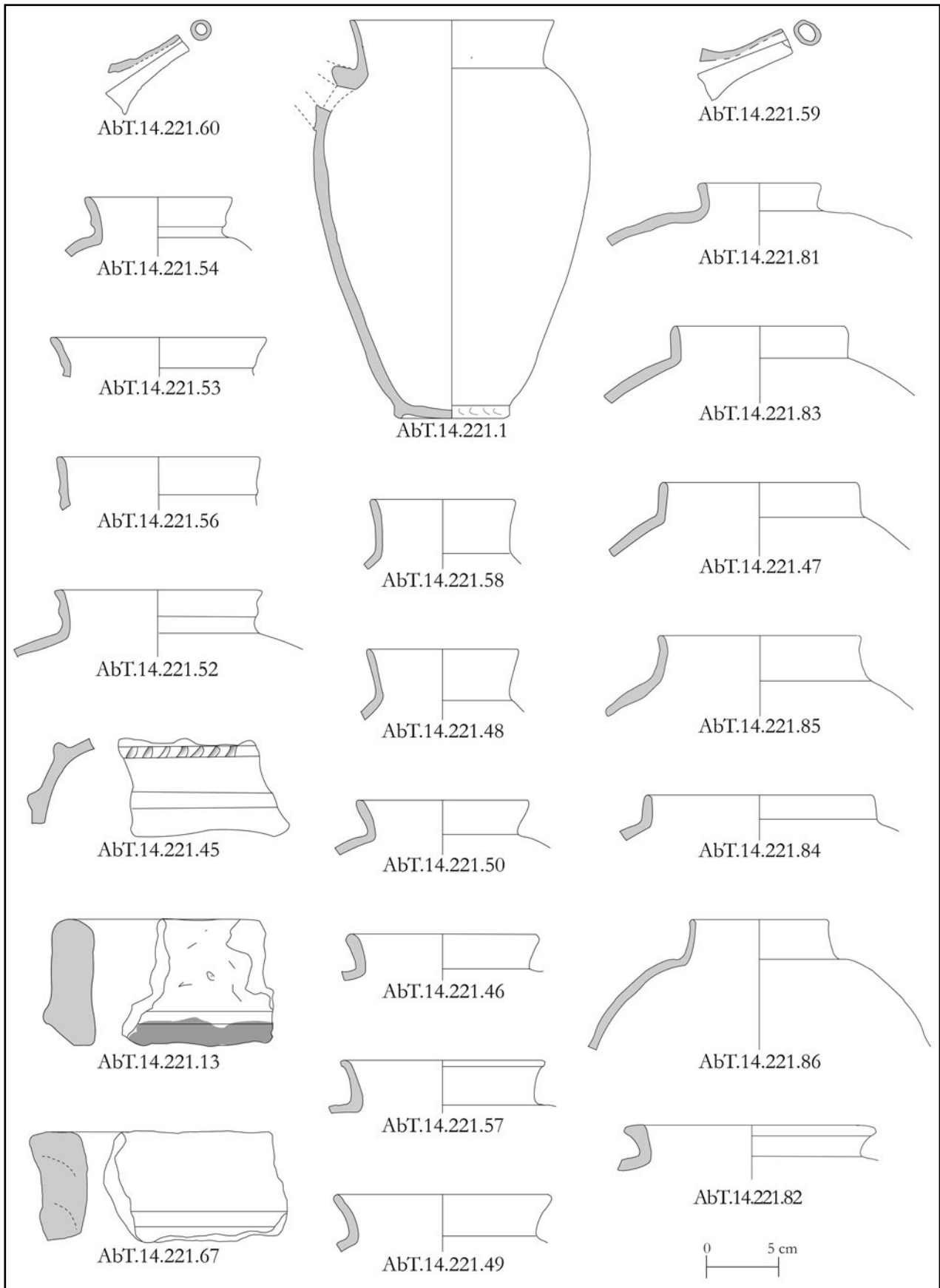

Fig. 7.55 US 221 pottery: closed and other shapes.

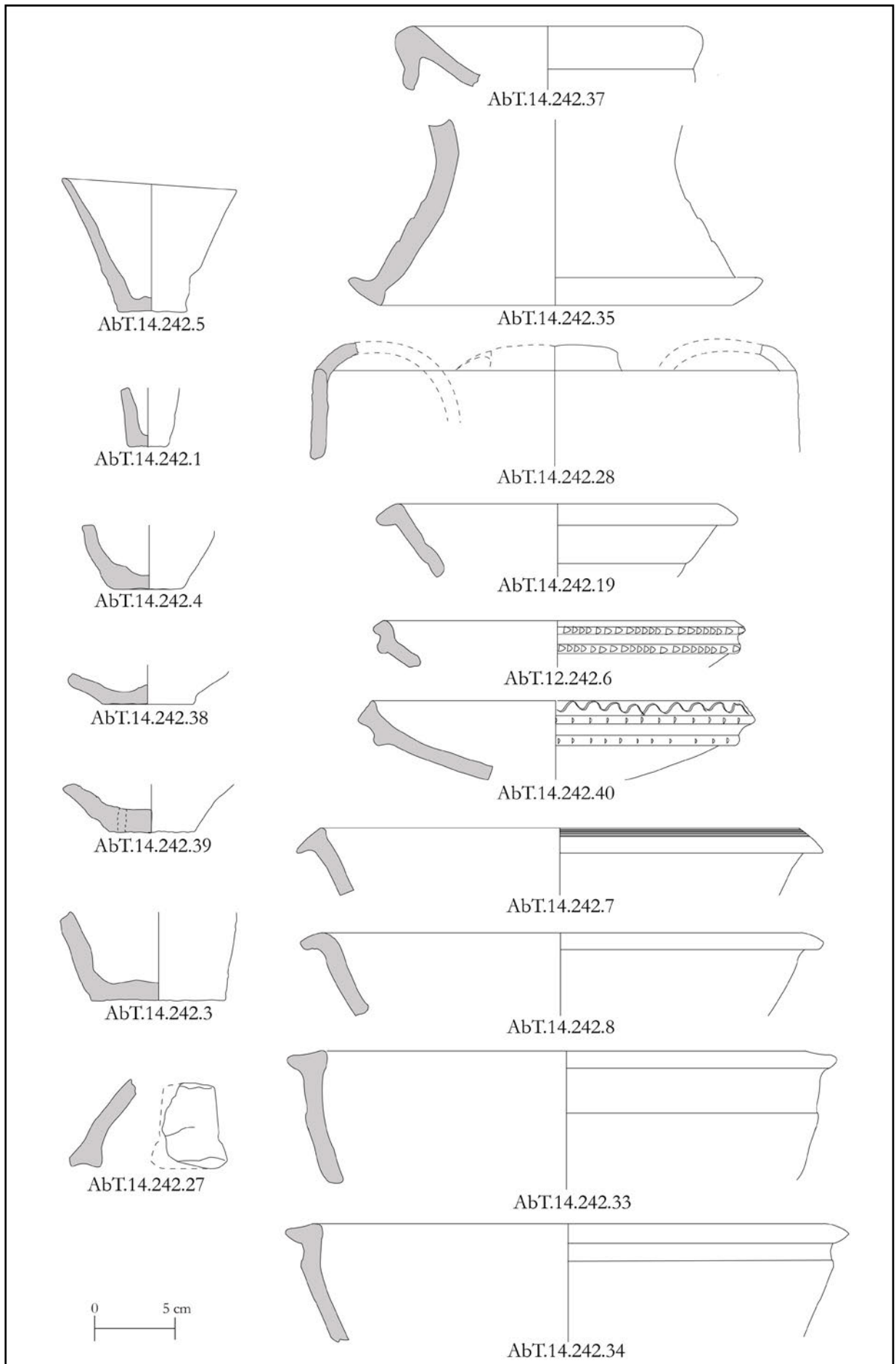

Fig. 7.56 US 242 pottery: open shapes.

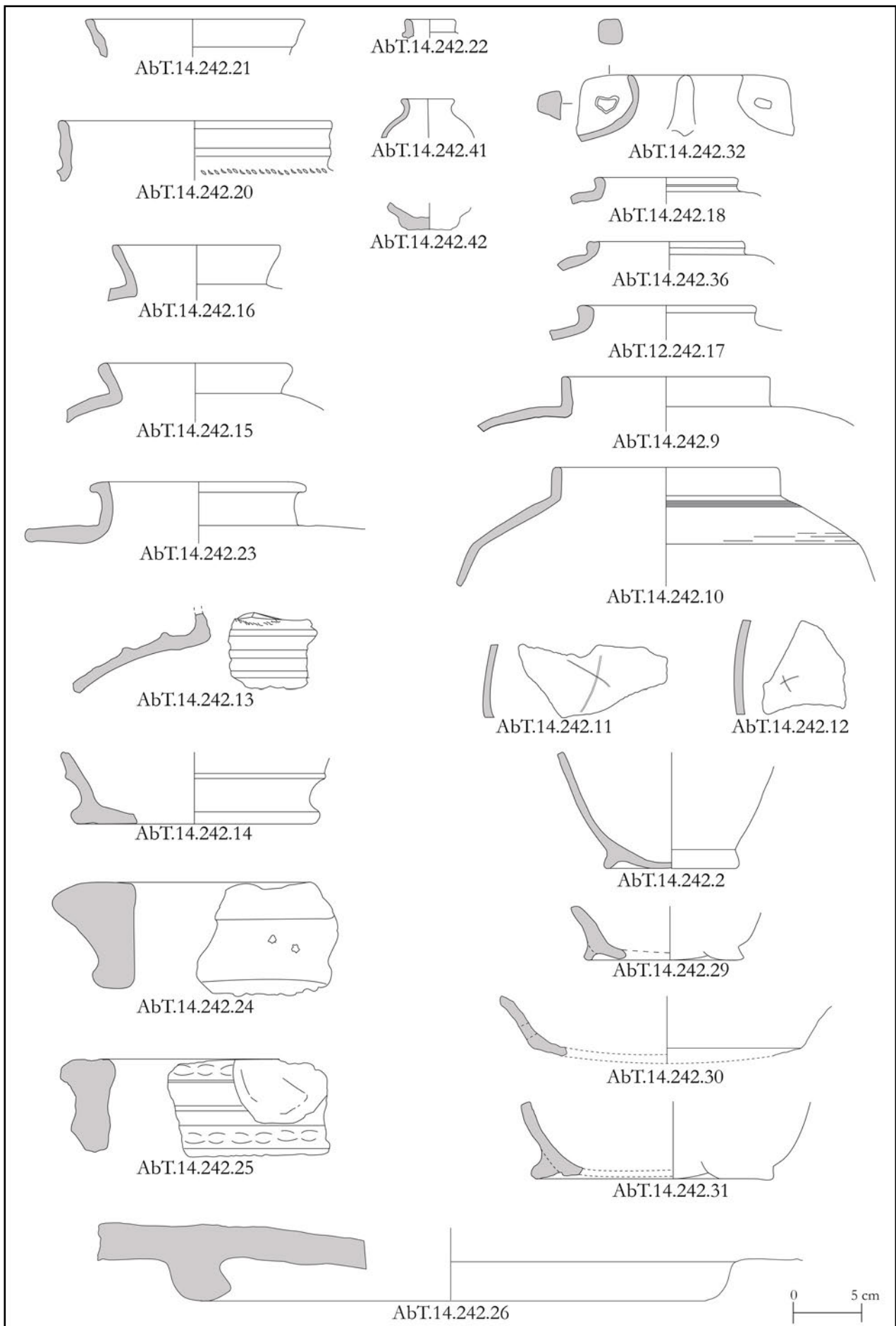

Fig. 7.57 US 242 pottery: closed and other shapes.

Catalogue of US 221 Finds

*Objects***AbT.14.3 - Fig. 7.50**

Description: chert blade.
Dimensions: 1.4x3.9x0.3 cm.

AbT.14.4 - Fig. 7.50

Description: small fragmented pebble.
1/4 of the original size. [SC]
Dimensions: 2.1x2.8x1.8 cm.

AbT.14.7 - Fig. 7.50

Description: pale greyish sedimentary
stone tool (pestle). [SC]
Dimensions: 3.6x7.8x4 cm.

AbT.14.8 - Fig. 7.50

Description: chert sickle element.
Dimensions: 0.4x2.2x0.3 cm.

AbT.14.16 - Fig. 7.50

Description: point of a clay cone.
Dimensions: 3.9x1x1 cm.

AbT.14.17 - Fig. 7.50

Description: reused fragment of
a pottery vessel. Use wear on the
margins.
Dimensions: 7x4.2x0.8 cm.

AbT.14.18 - Fig. 7.50

Description: chert sickle element.
Dimensions: 1.3x2.5x0.4 cm.

AbT.14.19 - Fig. 7.50

Description: chert sickle element.
Dimensions: 1.6x2.5x0.5 cm.

AbT.14.20 - Fig. 7.50

Description: chert sickle element.
Dimensions: 1.5x1.9x0.4 cm.

*Pottery***AbT.14.221.1 - Fig. 7.55**

Dimensions: rim diam.: 14 cm; rim th.:
0.5 cm; wall th.: 0.5 cm; base diam.: 7.7
cm; base th.: 0.7 cm; h.: 28 cm.
Clay: outer and inner colour: 2.5Y 8/2
(pale brown); fabric colour: 5YR 7/4
(pink); sand inclusions; medium-high
firing temperature.
Description: spouted jar.

AbT.14.221.2 - Fig. 7.53

Dimensions: wall th.: 2.4 base diam.:
33.5 cm; base th.: 1.6 cm.
Clay: outer, inner colour and fabric

colour: 5YR 7/6 (reddish yellow);
sand inclusions; medium-high firing
temperature.
Description: beaker base.

AbT.14.221.3 - Fig. 7.54

Dimensions: wall th.: 2.5 cm; base
diam.: 32 cm; base th.: 4 cm.
Clay: outer colour: 5YR 7/3 (pink);
inner and fabric colour: 5YR 6/4
(light reddish brown); sand and
vegetal inclusions; medium-high firing
temperature.
Description: base of a big jar with a
hole in the middle.

AbT.14.221.4 - Fig. 7.53

Dimensions: wall th.: 0.7 cm; base
diam.: 4.6 cm; base th.: 1.5 cm.
Clay: outer and inner colour: 10YR
8/3 (very pale brown); fabric colour:
2.5YR 6/6 (light red); sand inclusions;
medium-high firing temperature.
Description: conical bowl base.

AbT.14.221.5 - Fig. 7.54

Dimensions: wall th.: 0.7 cm; base th.:
1.4 cm.
Clay: outer colour: 10YR 8/2 (very pale
brown); inner colour and fabric colour:
5YR 6/4 (light reddish brown); sand
inclusions; medium firing temperature.
Description: pointed base.

AbT.14.221.6 - Fig. 7.53

Dimensions: wall th.: 0.9 cm; base
diam.: 4.5 cm; base th.: 1.1 cm.
Clay: outer, inner and fabric colour:
2.5Y 8/2 (pale brown); sand inclusions;
medium firing temperature.
Description: beaker base.

AbT.14.221.7 - Fig. 7.53

Dimensions: wall th.: 0.9 cm; base
diam.: 4.8 cm; base th.: 1.5 cm.
Clay: outer, inner, fabric colour: 5YR
7/4 (pink); sand inclusions; medium-
low firing temperature.
Description: beaker base.

AbT.14.221.8 - Fig. 7.53

Dimensions: wall th.: 0.9 cm; base
diam.: 4.5 cm; base th.: 1.3 cm.
Clay: outer, inner, fabric colour: 5YR
7/4 (pink); sand inclusions; medium-
low firing temperature.
Description: beaker base.

AbT.14.221.9 - Fig. 7.53

Dimensions: wall th.: 1.1 cm; base

diam.: 5 cm; base th.: 1.7 cm.

Clay: outer and fabric colour: 2.5YR
7/6 (light red); inner colour: 5YR
7/6 (reddish yellow); sand inclusions;
medium-low firing temperature.
Description: beaker base.

AbT.14.221.10 - Fig. 7.53

Dimensions: wall th.: 0.9 cm; base
diam.: 5 cm; base th.: 1.2 cm.
Clay: outer, inner and fabric colour: 5YR
7/6 (reddish yellow); sand inclusions;
medium-low firing temperature.
Description: beaker base.

AbT.14.221.11 - Fig. 7.53

Dimensions: wall th.: 1.2 cm; base
diam.: 5.5 cm; base th.: 1.6 cm.
Clay: outer, inner and fabric colour:
5Y 8/2 (pale yellow); sand inclusions;
medium firing temperature.
Description: beaker base.

AbT.14.221.12 - Fig. 7.54

Dimensions: rim diam.: 27 cm; rim th.:
1.2 cm; wall th.: 0.9 cm.
Clay: outer and inner colour: 10YR 8/2
(very pale brown); fabric colour: 5YR
6/6 (reddish yellow); sand inclusions;
medium firing temperature.
Description: triangular rim bowl.

AbT.14.221.13 - Fig. 7.55

Dimensions: rim th.: 2.9 cm.
Clay: outer and inner colour: 2.5Y 8/2
(pale brown); fabric colour: 7.5YR
6/6 (reddish yellow); sand and vegetal
inclusions; medium firing temperature.
Description: rim of a vat with a ridge
and a horizontal bitumen band on the
wall.

AbT.14.221.14 - Fig. 7.53

Dimensions: wall th.: 0.8 cm; base
diam.: 5.1 cm; base th.: 1.5 cm.
Clay: outer and inner colour: 2.5Y
8/2 (pale brown); fabric colour: 5YR
7/6 (reddish yellow); sand inclusions;
medium firing temperature.
Description: conical bowl base.

AbT.14.221.15 - Fig. 7.53

Dimensions: rim th.: 1.3 cm; wall th.:
1.7 cm; base diam.: 4.5 cm.
Clay: outer, inner and fabric colour:
7.5YR 7/4 (pink); sand inclusions;
medium-low firing temperature.
Description: conical bowl base.

AbT.14.221.16 - Fig. 7.53

Dimensions: wall th.: 0.9 cm; base diam.: 5.5 cm; base th.: 1 cm.
Clay: outer, inner and fabric colour: 7.5YR 7/6 (reddish yellow); sand inclusions; low firing temperature.
Description: conical bowl base.

AbT.14.221.17 - Fig. 7.53

Dimensions: wall th.: 1 cm; base diam.: 4.3 cm; base th.: 0.7 cm.
Clay: outer, inner and fabric colour: 7.5YR 7/6 (reddish yellow); sand inclusions; low firing temperature.
Description: conical bowl base.

AbT.14.221.18 - Fig. 7.53

Dimensions: wall th.: 0.7 cm; base diam.: 4.6 cm; base th.: 1.3 cm.
Clay: outer, inner and fabric colour: 7.5YR 7/6 (reddish yellow); sand inclusions; medium-low firing temperature.
Description: conical bowl base.

AbT.14.221.19 - Fig. 7.53

Dimensions: wall th.: 0.7 cm; base diam.: 5 cm; base th.: 0.4 cm.
Clay: outer, inner and fabric colour: 7.5YR 7/6 (reddish yellow); sand inclusions; medium-low firing temperature.
Description: conical bowl base.

AbT.14.221.20 - Fig. 7.53

Dimensions: wall th.: 0.7 cm; base diam.: 4 cm; base th.: 1.3 cm.
Clay: outer, inner and fabric colour: 7.5YR 7/6 (reddish yellow); sand inclusions; low firing temperature.
Description: beaker base.

AbT.14.221.21 - Fig. 7.53

Dimensions: wall th.: 0.9 cm; base diam.: 5 cm; base th.: 0.6 cm.
Clay: outer, inner and fabric colour: 7.5YR 7/6 (reddish yellow); sand inclusions; medium-low firing temperature.
Description: conical bowl base.

AbT.14.221.22 - Fig. 7.53

Dimensions: wall th.: 0.9 cm; base diam.: 5.6 cm; base th.: 0.7 cm.
Clay: outer, inner and fabric colour: 2.5Y 8/2 (pale brown); sand inclusions; medium firing temperature.
Description: conical bowl base.

AbT.14.221.23 - Fig. 7.53

Dimensions: wall th.: 0.9 cm; base diam.: 5 cm; base th.: 1 cm.
Clay: outer, inner and fabric colour: 2.5Y 8/2 (pale brown); sand inclusions; medium firing temperature.
Description: conical bowl base.

AbT.14.221.24 - Fig. 7.53

Dimensions: wall th.: 0.8 cm; base diam.: 5.5 cm; base th.: 0.9 cm.
Clay: outer, inner and fabric colour: 7.5YR 6/6 (reddish yellow); sand inclusions; medium-high firing temperature.
Description: conical bowl base.

AbT.14.221.25 - Fig. 7.53

Dimensions: wall th.: 0.9 cm; base diam.: 5.5 cm; base th.: 1 cm.
Clay: outer, inner and fabric colour: 2.5Y 8/3 (pale brown); sand inclusions; medium-high firing temperature.
Description: conical bowl base.

AbT.14.221.26 - Fig. 7.53

Dimensions: wall th.: 0.6 cm; base diam.: 5 cm; base th.: 1 cm.
Clay: outer, inner and fabric colour: 7.5YR 7/6 (reddish yellow); sand inclusions; low firing temperature.
Description: conical bowl base.

AbT.14.221.27 - Fig. 7.53

Dimensions: wall th.: 0.7 cm; base diam.: 5.2 cm; base th.: 1.2 cm.
Clay: outer, inner and fabric colour: 7.5YR 7/6 (reddish yellow); sand inclusions; low firing temperature.
Description: beaker base.

AbT.14.221.28 - Fig. 7.53

Dimensions: wall th.: 0.9 cm; base diam.: 5.3 cm; base th.: 0.7 cm.
Clay: outer, inner and fabric colour: 7.5YR 7/6 (reddish yellow); sand inclusions; medium-low firing temperature.
Description: conical bowl base.

AbT.14.221.29 - Fig. 7.53

Dimensions: wall th.: 1.8 cm; base diam.: 5.3 cm; base th.: 1.3 cm.
Clay: outer, inner and fabric colour: 7.5YR 7/6 (reddish yellow); sand inclusions; low firing temperature.
Description: conical bowl base.

AbT.14.221.30 - Fig. 7.54

Dimensions: rim diam.: 9 cm; rim th.:

1.3 cm; wall th.: 1 cm; base diam.: 4 cm; base th.: 1 cm; h.: 3.3 cm.
Clay: outer, inner and fabric colour: 2.5Y 8/3 (pale brown); sand inclusions; medium firing temperature.
Description: conical bowl attached to a stand.

AbT.14.221.31 - Fig. 7.54

Dimensions: rim diam.: 22 cm; rim th.: 1.2 cm; wall th.: 0.7 cm.
Clay: outer and inner colour: 10YR 8/2 (very pale brown); fabric colour: 2.5YR 6/4 (light reddish brown); sand inclusions; medium-high firing temperature.
Description: triangular rim bowl.

AbT.14.221.32 - Fig. 7.54

Dimensions: rim diam.: 28 cm; rim th.: 1 cm; wall th.: 1.1 cm.
Clay: outer and inner colour: 10YR 8/2 (very pale brown); fabric colour: 2.5YR 6/6 (light red); sand inclusions; medium firing temperature.
Description: triangular rim bowl.

AbT.14.221.33 - Fig. 7.54

Dimensions: wall th.: 0.8 cm; base diam.: 9 cm; base th.: 0.9 cm.
Clay: outer colour: 10YR 8/2 (very pale brown); inner and fabric colour: 7.5YR 7/4 (pink); sand inclusions; medium-high firing temperature.
Description: convex base with one foot preserved.

AbT.14.221.34 - Fig. 7.54

Dimensions: wall th.: 0.6 cm; base diam.: 19 cm; base th.: 0.6 cm.
Clay: outer colour: 10YR 8/2 (very pale brown); inner colour: 7.5YR 7/6 (reddish yellow); fabric colour: 2.5YR 5/6 (red); sand inclusions; medium-low firing temperature.
Description: convex base.

AbT.14.221.35 - Fig. 7.54

Dimensions: wall th.: 0.5 cm; base diam.: 18 cm; base th.: 0.6 cm.
Clay: outer, inner and fabric colour: 5YR 7/6 (reddish yellow); sand inclusions; medium-low firing temperature.
Description: convex base.

AbT.14.221.36 - Fig. 7.52

Dimensions: wall th.: 0.7 cm; base diam.: 8 cm; base th.: 0.4 cm.
Clay: outer, inner and fabric colour: 5YR 7/6 (reddish yellow); sand inclusions;

medium-high firing temperature.
Description: flat base.

AbT.14.221.37 - Fig. 7.54

Dimensions: wall th.: 0.7 cm; base diam.: 30 cm; base th.: 0.9 cm.
Clay: outer, inner and fabric colour: 5Y 8/3 (pale yellow); sand and vegetal inclusions; high firing temperature.
Description: flat base (jar or tray?).

AbT.14.221.38 - Fig. 7.54

Dimensions: wall th.: 0.6 cm; base diam.: 5 cm; base th.: 0.5 cm.
Clay: outer and inner colour (slip): 2.5Y 8/2 (pale brown); fabric colour: 5YR 7/4 (pink); sand inclusions; medium-low firing temperature.
Description: rounded base.

AbT.14.221.39 - Fig. 7.54

Dimensions: wall th.: 1.2 cm; base diam.: 13 cm; base th.: 1.2 cm.
Clay: outer and inner colour: 2.5Y 8/2 (pale brown); fabric colour: 5YR 6/4 (light reddish brown); sand and vegetal inclusions; high firing temperature.
Description: tray.

AbT.14.221.40 - Fig. 7.54

Dimensions: wall th.: 0.6 cm; base diam.: 11 cm; base th.: 0.8 cm.
Clay: outer, inner and fabric colour: 7.5YR 6/6 (reddish yellow); sand inclusions; low firing temperature.
Description: ring base.

AbT.14.221.41 - Fig. 7.54

Dimensions: wall th.: 0.9 cm; base diam.: 13.5 cm; base th.: 0.8 cm.
Clay: outer and inner colour: 7.5YR 7/6 (reddish yellow); fabric colour: 5YR 5/6 (yellowish red); sand inclusions; medium-low firing temperature.
Description: ring base.

AbT.14.221.42 - Fig. 7.54

Dimensions: base diam.: 14 cm; base th.: 1.1 cm.
Clay: outer and inner colour: 2.5Y 8/2 (pale brown); fabric colour: 5YR 7/4 (pink); sand inclusions; medium firing temperature.
Description: ring base.

AbT.14.221.43 - Fig. 7.54

Dimensions: wall th.: 0.8 cm; base diam.: 15 cm; base th.: 1.3 cm.
Clay: outer, inner and fabric colour: 7.5YR 6/4 (light brown); sand

inclusions; medium firing temperature.
Description: ring base.

AbT.14.221.44 - Fig. 7.54

Dimensions: wall th.: 0.9 cm; base diam.: 18 cm; base th.: 0.5 cm.
Clay: outer and inner colour: 7.5YR 8/3 (pink); fabric colour: 5YR 6/6 (reddish yellow); sand inclusions; medium-low firing temperature.
Description: ring base.

AbT.14.221.45 - Fig. 7.55

Dimensions: wall th.: 0.8 cm.
Clay: outer, inner and fabric colour: 2.5Y 8/2 (pale brown); sand inclusions; medium-high firing temperature.
Description: wall fragment decorated with two applied ridges (the lower one notched).

AbT.14.221.46 - Fig. 7.55

Dimensions: rim diam.: 14 cm; rim th.: 0.8 cm; wall th.: 0.7 cm.
Clay: outer colour: 10YR 8/2 (very pale brown); inner and fabric colour: 7.5YR 7/6 (reddish yellow); sand inclusions; medium-high firing temperature.
Description: plain rim jar.

AbT.14.221.47 - Fig. 7.55

Dimensions: rim diam.: 14 cm; rim th.: 0.7 cm; wall th.: 0.8 cm.
Clay: outer and inner colour: 2.5Y 8/2 (pale brown); fabric colour: 10YR 6/4 (light yellowish brown); sand inclusions; medium-high firing temperature.
Description: plain rim jar.

AbT.14.221.48 - Fig. 7.55

Dimensions: rim diam.: 10.5 cm; rim th.: 0.5 cm; wall th.: 0.6 cm.
Clay: outer and inner colour: 2.5Y 8/3 (pale brown); fabric colour: 7.5YR 6/6 (reddish yellow); sand inclusions; medium-high firing temperature.
Description: plain rim jar.

AbT.14.221.49 - Fig. 7.55

Dimensions: rim diam.: 15 cm; rim th.: 0.7 cm; wall th.: 0.7 cm.
Clay: outer, inner and fabric colour: 2.5Y 8/3 (pale brown); sand inclusions; medium-high firing temperature.
Description: plain rim jar.

AbT.14.221.50 - Fig. 7.55

Dimensions: rim diam.: 12 cm; rim th.: 0.7 cm; wall th.: 0.6 cm.
Clay: outer and inner colour: 2.5Y

8/2 (pale brown); fabric colour: 5YR 6/6 (reddish yellow); sand inclusions; medium-high firing temperature.
Description: plain rim jar.

AbT.14.221.51 - Fig. 7.54

Dimensions: rim diam.: 26 cm; rim th.: 2.1 cm; wall th.: 0.9 cm.
Clay: outer, inner and fabric colour: 7.5YR 7/4 (pink); sand inclusions; medium-low firing temperature.
Description: triangular rim bowl.

AbT.14.221.52 - Fig. 7.55

Dimensions: rim diam.: 14 cm; rim th.: 0.7 cm; wall th.: 0.7 cm.
Clay: outer ("reserved slip like" effect) and inner colour: 2.5Y 8/2 (pale brown); fabric colour: 5YR 6/4 (light reddish brown); sand inclusions; medium-high firing temperature.
Description: double-ridged rim jar.

AbT.14.221.53 - Fig. 7.55

Dimensions: rim diam.: 15 cm; rim th.: 0.6 cm.
Clay: outer and inner colour: 2.5Y 8/2 (pale brown); fabric colour: 5YR 5/4 (reddish brown); sand and vegetal inclusions; medium-high firing temperature.
Description: band rim jar.

AbT.14.221.54 - Fig. 7.55

Dimensions: rim diam.: 15 cm; rim th.: 0.6 cm; wall th.: 0.7 cm.
Clay: outer and inner colour: 2.5Y 8/2 (pale brown); fabric colour: 7.5YR 6/4 (light brown); sand inclusions; medium-high firing temperature.
Description: band rim jar.

AbT.14.221.55 - Fig. 7.54

Dimensions: rim diam.: n.d.; rim th.: 1.8 cm.
Clay: outer and inner colour: 7.5YR 8/2 (pinkish white); fabric colour: 7.5YR 5/6 (strong brown); sand inclusions; medium-low temperature.
Description: triangular rim bowl.

AbT.14.221.56 - Fig. 7.55

Dimensions: rim diam.: 14 cm; rim th.: 0.6 cm.
Clay: outer and inner colour: 2.5Y 8/2 (pale brown); fabric colour: 5YR 5/6 (yellowish red); sand inclusions; medium firing temperature.
Description: band rim jar.

AbT.14.221.57 - Fig. 7.55

Dimensions: rim diam.: 15 cm; rim th.: 0.6 cm; wall th.: 0.5 cm.

Clay: outer and inner colour: 2.5Y 8/2 (pale brown); fabric colour: 2.5Y 7/2 (light grey); sand inclusions; high firing temperature.

Description: plain rim jar.

AbT.14.221.58 - Fig. 7.55

Dimensions: rim diam.: 10 cm; rim th.: 0.5 cm; wall th.: 0.6 cm.

Clay: outer and inner colour: 2.5Y 8/2 (pale brown); fabric colour: 10YR 7/6 (yellow); sand inclusions; medium-high firing temperature.

Description: plain rim jar.

AbT.14.221.59 - Fig. 7.55

Dimensions: wall th.: 1 cm.

Clay: outer and inner colour: 10YR 7/3 (very pale brown); fabric colour: 10YR 6/4 (light yellowish brown); sand inclusions; medium-high firing temperature.

Description: spout.

AbT.14.221.60 - Fig. 7.55

Dimensions: wall th.: 0.8 cm.

Clay: outer colour: 5Y 8/2 (pale yellow); inner and fabric colour: 2.5Y 7/3 (pale brown); sand inclusions; medium-high firing temperature.

Description: spout.

AbT.14.221.61 - Fig. 7.54

Dimensions: rim diam.: 15.5 cm; rim th.: 0.6 cm; wall th.: 0.7 cm.

Clay: outer and inner colour: 2.5Y 8/2 (pale brown); fabric colour: 10YR 7/6 (yellow); sand inclusions; medium-high firing temperature.

Description: drinking vessel rim.

AbT.14.221.62 - Fig. 7.54

Dimensions: rim diam.: 18 cm; rim th.: 0.6 cm; wall th.: 0.6 cm.

Clay: outer, inner and fabric colour: 5YR 6/6 (reddish yellow); sand inclusions; low firing temperature.

Description: drinking vessel rim.

AbT.14.221.63 - Fig. 7.54

Dimensions: rim diam.: 15 cm; rim th.: 0.7 cm; wall th.: 1 cm.

Clay: outer, inner and fabric colour: 2.5Y 8/2 (pale brown); sand inclusions; medium-high firing temperature.

Description: drinking vessel rim.

AbT.14.221.64 - Fig. 7.54

Dimensions: rim diam.: 16 cm; rim th.: 0.6 cm; wall th.: 0.7 cm.

Clay: outer, inner and fabric colour: 7.5YR 6/4 (light brown); sand inclusions; medium-high firing temperature.

Description: drinking vessel rim.

AbT.14.221.65 - Fig. 7.54

Dimensions: rim diam.: 15 cm; rim th.: 0.6 cm; wall th.: 0.7 cm.

Clay: outer, inner and fabric colour: 7.5YR 6/4 (light brown); sand inclusions; medium-high firing temperature.

Description: drinking vessel rim.

AbT.14.221.66 - Fig. 7.54

Dimensions: rim diam.: 13 cm; rim th.: 0.5 cm; wall th.: 0.6 cm.

Clay: outer and inner colour: 10YR 8/3 (very pale brown); fabric colour: 7.5YR 6/4 (light brown); sand inclusions; medium-high firing temperature.

Description: drinking vessel rim.

AbT.14.221.67 - Fig. 7.55

Dimensions: rim diam.: n.d. cm; rim th.: 3.7 cm; wall th.: 2.2 cm.

Clay: outer, inner and fabric colour: 2.5Y 8/2 (pale brown); sand and vegetal inclusions; high firing temperature.

Description: vat/big jar rim.

AbT.14.221.68 - Fig. 7.53

Dimensions: wall th.: 0.7 cm; base diam.: 5 cm; base th.: 0.8 cm.

Clay: outer and inner colour: 2.5Y 8/2 (pale brown); fabric colour: 10YR 7/6 (yellow); sand inclusions; medium-high firing temperature.

Description: conical bowl base.

AbT.14.221.69 - Fig. 7.53

Dimensions: wall th.: 0.8 cm; base diam.: 5.4 cm; base th.: 1.9 cm.

Clay: outer and inner colour: 5YR 7/6 (reddish yellow); fabric colour: 2.5YR 5/6 (red); sand inclusions; medium-low firing temperature.

Description: beaker base.

AbT.14.221.70 - Fig. 7.53

Dimensions: wall th.: 1.2 cm; base diam.: 5 cm; base th.: 0.8 cm.

Clay: outer and inner colour: 2.5Y 8/4 (pale brown); fabric colour: 10YR 7/6 (yellow); sand inclusions; medium-high

firing temperature.

Description: beaker base.

AbT.14.221.71 - Fig. 7.53

Dimensions: wall th.: 0.6 cm; base diam.: 5 cm; base th.: 1.3 cm.

Clay: outer, inner and fabric colour: 5Y 7/3 (pale yellow); sand inclusions; high firing temperature.

Description: beaker base.

AbT.14.221.72 - Fig. 7.53

Dimensions: wall th.: 1.2 cm; base diam.: 4.7 cm; base th.: 1 cm.

Clay: outer, inner and fabric colour: 10YR 7/3 (very pale brown); sand inclusions; medium-high firing temperature.

Description: beaker base.

AbT.14.221.73 - Fig. 7.53

Dimensions: wall th.: 0.8 cm; base diam.: 4.2 cm; base th.: 1.7 cm.

Clay: outer and inner colour: 2.5Y 8/2 (pale brown); fabric colour: 10YR 7/3 (very pale brown); sand inclusions; medium-high firing temperature.

Description: beaker (?) base.

AbT.14.221.74 - Fig. 7.53

Dimensions: wall th.: 0.9 cm; base diam.: 5 cm; base th.: 1 cm.

Clay: outer and inner colour: 2.5Y 8/2 (pale brown); fabric colour: 5YR 5/6 (yellowish red); sand inclusions; medium firing temperature.

Description: conical bowl base.

AbT.14.221.75 - Fig. 7.53

Dimensions: wall th.: 1 cm; base diam.: 5.5 cm; base th.: 0.8 cm.

Clay: outer, inner and fabric colour: 5YR 7/6 (reddish yellow); sand inclusions; medium-low firing temperature.

Description: conical bowl base.

AbT.14.221.76 - Fig. 7.53

Dimensions: wall th.: 1 cm; base diam.: 5 cm; base th.: 0.8 cm.

Clay: outer, inner and fabric colour: 2.5Y 8/2 (pale brown); sand inclusions; medium-high firing temperature.

Description: conical bowl base.

AbT.14.221.77 - Fig. 7.53

Dimensions: wall th.: 0.7 cm; base diam.: 4 cm; base th.: 1.5 cm.

Clay: outer, inner and fabric colour:

5YR 6/4 (light reddish brown); sand inclusions; low firing temperature.
Description: conical bowl base.

AbT.14.221.78 - Fig. 7.54

Dimensions: rim diam.: 35 cm; rim th.: 2 cm; wall th.: 1.1 cm.
Clay: outer and inner colour (self-slip): 10YR 8/2 (very pale brown); fabric colour: 5YR 5/4 (reddish brown); sand inclusions; medium firing temperature.
Description: triangular rim bowl.

AbT.14.221.79 - Fig. 7.54

Dimensions: rim diam.: 24 cm; rim th.: 2 cm; wall th.: 1 cm.
Clay: outer and inner colour: 5YR 7/6 (reddish yellow); fabric colour: 2.5YR 5/6 (red); sand inclusions; medium-low firing temperature.
Description: triangular rim bowl.

AbT.14.221.80 - Fig. 7.54

Dimensions: rim diam.: 15 cm; rim th.: 0.5 cm; wall th.: 0.5 cm.
Clay: outer and inner colour: 10YR 8/2 (very pale brown); fabric colour: 5YR 7/6 (reddish yellow); sand inclusions; medium-high firing temperature.
Description: drinking vessel rim.

AbT.14.221.81 - Fig. 7.55

Dimensions: rim diam.: 9 cm; rim th.: 0.7 cm; wall th.: 0.9 cm.
Clay: outer colour: 2.5Y 8/2 (pale brown); inner and fabric colour: 5YR 7/4 (pink); sand inclusions; medium-high firing temperature.
Description: plain rim jar.

AbT.14.221.82 - Fig. 7.55

Dimensions: rim diam.: 15 cm; rim th.: 1.2 cm; wall th.: 0.8 cm.
Clay: outer, inner and fabric colour: 5Y 8/2 (pale yellow); sand inclusions; medium-high firing temperature.
Description: triangular rim jar.

AbT.14.221.83 - Fig. 7.55

Dimensions: rim diam.: 12 cm; rim th.: 0.6 cm; wall th.: 0.7 cm.
Clay: outer, inner and fabric colour: 5Y 7/2 (light grey); sand inclusions; medium-high firing temperature.
Description: plain rim jar.

AbT.14.221.84 - Fig. 7.55

Dimensions: rim diam.: 16 cm; rim th.: 0.8 cm; wall th.: 0.6 cm.
Clay: outer, inner and fabric colour: 5Y

8/2 (pale yellow); sand inclusions; high firing temperature.
Description: plain rim jar.

AbT.14.221.85 - Fig. 7.55

Dimensions: rim diam.: 14 cm; rim th.: 0.5 cm; wall th.: 0.8 cm.
Clay: outer, inner and fabric colour: 5Y 8/2 (pale yellow); sand inclusions; high firing temperature.
Description: plain rim jar.

AbT.14.221.86 - Fig. 7.55

Dimensions: rim diam.: 10 cm; rim th.: 0.5 cm; wall th.: 0.7 cm.
Clay: outer and inner colour (self-slip): 2.5Y 8/3 (pale brown); fabric colour: 2.5Y 8/3 (pale brown); sand inclusions; high firing temperature.
Description: plain rim jar.

AbT.14.221.87 - Fig. 7.54

Dimensions: base diam.: 8 cm; base th.: 0.6 cm.
Clay: outer and inner colour: 2.5Y 8/2 (pale brown); fabric colour: 5YR 6/6 (reddish yellow); sand inclusions; medium firing temperature.
Description: round base with one foot preserved.

AbT.14.221.88 - Fig. 7.54

Dimensions: wall th.: 0.9 cm; base diam.: 10 cm; base th.: 0.5 cm.
Clay: outer and inner colour: 10YR 7/3 (very pale brown); fabric colour: 5YR 5/4 (reddish brown); sand inclusions; medium-high firing temperature.
Description: convex base jar with two feet preserved.

AbT.14.221.89 - Fig. 7.54

Dimensions: base diam.: 21 cm; base th.: 1 cm.
Clay: outer, inner and fabric colour: 10YR 8/2 (very pale brown); sand and vegetal inclusions; medium-high firing temperature.
Description: convex base with one foot preserved.

AbT.14.221.90 - Fig. 7.54

Dimensions: wall th.: 0.7 cm; base diam.: 10.5 cm; base th.: 0.5 cm.
Clay: outer and inner colour: 2.5Y 7/2 (light grey); fabric colour: 7.5YR 4/6 (strong brown); sand inclusions; high firing temperature.
Description: convex base jar with two feet preserved.

Catalogue of US 242 Finds

Objects

AbT.14.27 - Fig. 7.51

Description: alabastrine limestone vessel fragment found inside AbT.14.242.2.
Dimensions: 3x4.5x0.5 cm.

AbT.14.30 - Fig. 7.51

Description: alabastrine limestone vessel fragment.
Dimensions: 6x4.4x0.5 cm.

AbT.14.32 - Fig. 7.51

Description: chert sickle element.
Dimensions: 3x1x0.5 cm.

AbT.14.35 - Fig. 7.51

Description: alabastrine limestone vessel rim fragment.
Dimensions: 5x4.2x0.4 cm.

AbT.14.36 - Fig. 7.51

Description: stone vessel rim fragment.
Dimensions: 3.2x2.5x0.3 cm.

AbT.14.37 - Fig. 7.51

Description: poorly preserved clay figurine.
Dimensions: 5.5x4x2.2 cm.

AbT.14.38 - Fig. 7.51

Description: stone hammerstone/pestle fragment.
Dimensions: 4.4x4x3 cm.

AbT.14.39 - Fig. 7.51

Description: 3 fragments of an alabastrine limestone vessel.
Dimensions: 3x1.3x0.3 cm; 1.6x1.2x0.3 cm; 1.3x0.7x0.3 cm.

AbT.14.45 - Fig. 7.51

Description: fragment (left part broken) of a clay tablet. Inscription not preserved.
Dimensions: 2.3x2.6x1.5 cm.

AbT.14.65 - Fig. 7.51

Description: chert sickle element.
Dimensions: 2.6x1.3x0.4 cm.

AbT.14.66 - Fig. 7.51

Description: chert sickle element.
Dimensions: 2.8x1.2x0.3 cm.

AbT.14.67 - Fig. 7.51

Description: fragment of a clay tablet.

Inscription not preserved.
Dimensions: 4.4x3.3x0.8 cm.

AbT.14.68 - Fig. 7.51

Description: half loom weight.
Dimensions: 6.2x1.9x1.9 cm.

AbT.14.69 - Fig. 7.51

Description: chert blade.
Dimensions: 3.5x1.4x0.3 cm.

AbT.14.70 - Fig. 7.51

Description: 2 fragments of an alabastrine limestone vessel with plain rim.
Dimensions: 4.9x3.1x0.4 cm; 4.2x2.2x0.4 cm.

AbT.14.71 - Fig. 7.51

Description: stone bead (rock crystal?).
Dimensions: 1.4x1.1x0.5 cm.

AbT.14.72 - Fig. 7.51

Description: greyish hammerstone.
Dimensions: 6.4x5.1x2.5 cm.

Pottery

AbT.14.242.1 - Fig. 7.56

Dimensions: wall th.: 0.8 cm; base diam.: 2.5 cm; base th.: 0.8 cm.
Clay: outer and inner colour: 10YR 8/3 (very pale brown); fabric colour: 7.5YR 5/6 (strong brown); sand inclusions; medium-high firing temperature.
Description: miniaturistic beaker base.

AbT.14.242.2 - Fig. 7.57

Dimensions: wall th.: 0.6 cm; base diam.: 9.5 cm; base th.: 0.6 cm.
Clay: outer and inner colour: 10YR 8/3 (very pale brown); fabric colour: 5YR 6/4 (light reddish brown); sand inclusions; medium-high firing temperature.
Description: ring base.

AbT.14.242.3 - Fig. 7.56

Dimensions: wall th.: 0.9 cm; base diam.: 8.5 cm; base th.: 1 cm.
Clay: outer, inner and fabric colour: 2.5YR 6/8 (light red); sand inclusions; medium-low firing temperature.
Description: big string cut base (jar or drinking vessel?).

AbT.14.242.4 - Fig. 7.56

Dimensions: wall th.: 0.8 cm; base diam.: 4.5 cm; base th.: 0.8 cm.
Clay: outer, inner and fabric colour:

2.5YR 6/6 (light red); sand inclusions; medium-low firing temperature.
Description: conical bowl base.

AbT.14.242.5 - Fig. 7.56

Dimensions: rim diam.: 10 cm; rim th.: 0.5 cm; wall th.: 0.6 cm; base diam.: 4.5 cm; base th.: 1 cm; h.: 8 cm.
Clay: outer, inner and fabric colour: 10YR 8/2 (very pale brown); sand inclusions; medium-high firing temperature.
Description: beaker.

AbT.14.242.6 - Fig. 7.56

Dimensions: rim diam.: 22 cm; rim th.: 1.2 cm.
Clay: outer and inner colour: 7.5YR 7/3 (pink); fabric colour: 2.5YR 5/4 (reddish brown); sand inclusions; medium-low firing temperature.
Description: stemmed-dish bowl with notched decoration.

AbT.14.242.7 - Fig. 7.56

Dimensions: rim diam.: 30 cm; rim th.: 2.2 cm; wall th.: 0.9 cm.
Clay: outer and inner colour: 7.5YR 7/6 (reddish yellow); fabric colour: 2.5YR 5/6 (red); sand inclusions; medium-high firing temperature.
Description: triangular rim bowl with light combed decoration (or heavy technological traces?) on the upper part of the rim.

AbT.14.242.8 - Fig. 7.56

Dimensions: rim diam.: 30 cm; rim th.: 2.2 cm; wall th.: 1.1 cm.
Clay: outer and inner colour: 10YR 8/3 (very pale brown); fabric colour: 2.5YR 6/8 (light red); sand inclusions; medium firing temperature.
Description: triangular rim bowl.

AbT.14.242.9 - Fig. 7.57

Dimensions: rim diam.: 15 cm; rim th.: 0.6 cm; wall th.: 0.7 cm.
Clay: outer, inner and fabric colour: 10YR 8/3 (very pale brown); sand inclusions; high firing temperature.
Description: plain rim jar.

AbT.14.242.10 - Fig. 7.57

Dimensions: rim diam.: 16.5 cm; rim th.: 0.7 cm; wall th.: 0.6 cm.
Clay: outer, inner and fabric colour: 5Y 8/2 (pale yellow); sand inclusions; medium-high firing temperature.
Description: plain rim jar decorated

with three incised and parallel lines under the neck.

AbT.14.242.11 - Fig. 7.57

Dimensions: wall th.: 0.5 cm.
Clay: outer colour: 7.5YR 8/2 (pinkish white); inner and fabric colour: 5YR 5/6 (yellowish red); sand inclusions; medium-high firing temperature.
Description: wall fragment with potter's mark (cross).

AbT.14.242.12 - Fig. 7.57

Dimensions: wall th.: 0.6 cm.
Clay: outer, inner and fabric colour: 5YR 4/6 (yellowish red); sand inclusions; medium-high firing temperature.
Description: wall fragment with potter's mark (cross).

AbT.14.242.13 - Fig. 7.57

Dimensions: wall th.: 0.85 cm.
Clay: outer colour (self-slip): 2.5Y 7/2 (light grey); inner colour: 7.5YR 8/3 (pink); fabric colour: 2.5YR 6/6 (light red); sand inclusions; medium-high firing temperature.
Description: fragment of a jar with several ridges (same of AbT.14.242.14). Oblique incisions at the join between the neck and the shoulder.

AbT.14.242.14 - Fig. 7.57

Dimensions: wall th.: 0.8 cm; base diam.: 18 cm; base th.: 0.5 cm.
Clay: outer colour (self-slip): 7.5YR 8/3 (pink); inner colour: 7.5YR 8/3 (pink); fabric colour: 5YR 6/4 (light reddish brown); sand inclusions; medium-high firing temperature.
Description: jar base with a ridge over it (same of AbT.14.242.13).

AbT.14.242.15 - Fig. 7.57

Dimensions: rim diam.: 13.5 cm; rim th.: 0.9 cm; wall th.: 0.8 cm.
Clay: outer, inner and fabric colour: 2.5Y 8/3 (pale brown); sand inclusions; medium-high firing temperature.
Description: plain rim jar.

AbT.14.242.16 - Fig. 7.57

Dimensions: rim diam.: 12.5 cm; rim th.: 0.7 cm; wall th.: 0.8 cm.
Clay: outer, inner and fabric colour: 2.5Y 8/3 (pale brown); sand inclusions; medium-high firing temperature.
Description: plain rim jar.

AbT.14.242.17 - Fig. 7.57

Dimensions: rim diam.: 12.5 cm; rim th.: 1.2 cm; wall th.: 0.6 cm.

Clay: outer, inner and fabric colour: 7.5YR 7/3 (pink); sand inclusions; medium-low firing temperature.

Description: plain rim jar.

AbT.14.242.18 - Fig. 7.57

Dimensions: rim diam.: 10 cm; rim th.: 0.7 cm; wall th.: 0.7 cm.

Clay: outer and inner colour: 7.5YR 7/2 (pinkish grey); fabric colour: 5YR 6/6 (reddish yellow); sand inclusions; medium firing temperature.

Description: plain rim jar.

AbT.14.242.19 - Fig. 7.56

Dimensions: rim diam.: 20 cm; rim th.: 1.9 cm; wall th.: 1 cm.

Clay: outer, inner and fabric colour: 2.5Y 8/2 (pale brown); sand inclusions; medium-high firing temperature.

Description: triangular rim bowl.

AbT.14.242.20 - Fig. 7.57

Dimensions: rim diam.: 20 cm; rim th.: 0.8 cm.

Clay: outer, inner and fabric colour: 7.5YR 8/3 (pink); sand inclusions; medium firing temperature.

Description: band rim jar with small incisions at the base of the neck.

AbT.14.242.21 - Fig. 7.57

Dimensions: rim diam.: 16 cm; rim th.: 0.6 cm.

Clay: outer, inner and fabric colour: 2.5Y 8/2 (pale brown); sand inclusions; medium-high firing temperature.

Description: band rim jar.

AbT.14.242.22 - Fig. 7.57

Dimensions: rim diam.: 3.5 cm; rim th.: 0.6 cm.

Clay: outer, inner and fabric colour: 5YR 6/6 (reddish yellow); sand inclusions; medium firing temperature.

Description: plain rim of a miniaturistic jar.

AbT.14.242.23 - Fig. 7.57

Dimensions: rim diam.: 13 cm; rim th.: 1.7 cm; wall th.: 1 cm.

Clay: outer, inner and fabric colour: 5Y 6/3 (pale olive); sand inclusions; high firing temperature.

Description: triangular rim jar.

AbT.14.242.24 - Fig. 7.57

Dimensions: rim diam.: n.d. cm; rim th.: 6.2 cm.

Clay: outer, inner and fabric colour: 5YR 6/4 (light reddish brown); sand and vegetal inclusions; medium firing temperature.

Description: double ridged rim of a big vat. Same vessel of AbT.14.242.25 where the notches on the ridge are more visible.

AbT.14.242.25 - Fig. 7.57

Dimensions: rim diam.: n.d. cm; rim th.: 4.3 cm.

Clay: outer (self-slip), inner and fabric colour: 10YR 7/3 (very pale brown); sand and vegetal inclusions; medium-high firing temperature.

Description: double ridged rim of a big vat with very damaged notched ridges. Same vessel of AbT.14.242.24 (notches on the ridge not clearly visible).

AbT.14.242.26 - Fig. 7.57

Dimensions: base diam.: 41 cm ca.; base th.: 2.4 cm.

Clay: outer, inner and fabric colour: 7.5YR 7/4 (pink); sand and vegetal inclusions; medium-high firing temperature.

Description: ring base.

AbT.14.242.27 - Fig. 7.56

Dimensions: wall th.: 1.3 cm.

Clay: outer and inner colour: 10YR 8/2 (very pale brown); fabric colour: 7.5YR 5/4 (brown); sand and vegetal inclusions; medium firing temperature.

Description: fragment of one "arm" of a "brazier".

AbT.14.242.28 - Fig. 7.56

Dimensions: rim diam.: 30 cm(?); rim th.: 0.8 cm.

Clay: outer and inner colour: 10YR 8/2 (very pale brown); fabric colour: 5YR 6/4 (light reddish brown); sand and vegetal inclusions; medium firing temperature.

Description: rim and the attachment of one "arm" of a "brazier".

AbT.14.242.29 - Fig. 7.57

Dimensions: base diam.: 12 cm; base th.: 0.7 cm.

Clay: outer, inner and fabric colour: 2.5Y 8/2 (pale brown); sand inclusions; medium-high firing temperature.

Description: convex base jar with one foot.

AbT.14.242.30 - Fig. 7.57

Dimensions: wall th.: 0.7 cm; base diam.: 20 cm; base th.: 0.7 cm.

Clay: outer and inner colour: 10YR 8/3 (very pale brown); fabric colour: 5YR 6/4 (light reddish brown); sand inclusions; medium firing temperature.

Description: convex base with a small hole immediately over it.

AbT.14.242.31 - Fig. 7.57

Dimensions: wall th.: 1 cm; base diam.: 19 cm; base th.: 0.8 cm.

Clay: outer, inner and fabric colour: 5YR 6/4 (light reddish brown); sand inclusions; medium-high firing temperature.

Description: convex base jar with one foot preserved.

AbT.14.242.32 - Fig. 7.57

Dimensions: rim diam.: 8 cm; rim th.: 0.5 cm.

Clay: outer and inner colour: 2.5Y 8/2 (pale brown); fabric colour: 7.5YR 7/4 (pink); sand inclusions; medium firing temperature.

Description: plain rim jar with vertical handle attached to the rim.

AbT.14.242.33 - Fig. 7.56

Dimensions: rim diam.: 31 cm; rim th.: 2.2 cm; wall th.: 1 cm.

Clay: outer colour: 5YR 7/6 (reddish yellow); inner and fabric colour: 5YR 5/6 (yellowish red); sand inclusions; medium firing temperature.

Description: rim of a big bowl or base of a stemmed-dish.

AbT.14.242.34 - Fig. 7.56

Dimensions: rim diam.: 22 cm; rim th.: 2.3 cm; wall th.: 1 cm;

Clay: outer, inner and fabric colour: 7.5YR 6/6 (reddish yellow); sand inclusions; medium firing temperature.

Description: triangular rim bowl.

AbT.14.242.35 - Fig. 7.56

Dimensions: wall th.: 1.2 cm; base diam.: 20 cm; base th.: 2.4 cm.

Clay: outer, inner and fabric colour: 2.5Y 8/2 (pale brown); sand inclusions; medium-high firing temperature.

Description: stand.

AbT.14.242.36 - Fig. 7.57

Dimensions: rim diam.: 11 cm; rim th.: 1 cm; wall th.: 0.8 cm.

Clay: outer colour: 2.5Y 8/2 (pale brown); inner colour and fabric colour: 7.5YR 7/4 (pink); sand inclusions; medium-high firing temperature.

Description: plain rim jar.

AbT.14.242.37 - Fig. 7.56

Dimensions: rim diam.: 17 cm; rim th.: 2 cm; wall th.: 0.8 cm.

Clay: outer, inner and fabric colour: 5Y 8/3 (pale yellow); sand and vegetal inclusions; medium-high firing temperature.

Description: conical bowl attached to a stand (AbT.14.242.35?).

AbT.14.242.38 - Fig. 7.56

Dimensions: wall th.: 0.8 cm; base diam.: 6 cm; base th.: 1 cm.

Clay: outer colour: 2.5Y 8/3 (pale brown); inner and fabric colour: 7.5YR 7/4 (pink); sand inclusions; medium firing temperature.

Description: conical bowl base.

AbT.14.242.39 - Fig. 7.56

Dimensions: wall th.: 0.9 cm; base diam.: 5.7 cm; base th.: 1 cm.

Clay: outer, inner and fabric colour: 5Y 8/3 (pale yellow); sand inclusions; medium-high firing temperature.

Description: conical bowl base, pierced in the middle before firing (funnel).

AbT.14.242.40 - Fig. 7.56

Dimensions: rim diam.: 23 cm; rim th.: 1.4 cm; wall th.: 1 cm.

Clay: outer, inner and fabric colour: 7.5YR 7/6 (reddish yellow); sand inclusions; medium firing temperature.

Description: stemmed-dish bowl. Notched rim and weavy incision on the upper part.

AbT.14.242.41 - Fig. 7.57

Dimensions: rim diam.: 4 cm; rim th.: 0.5 cm; wall th.: 0.5 cm.

Clay: outer, inner and fabric colour: 2.5Y 8/2 (pale brown); sand inclusions; medium-high firing temperature.

Description: plain rim of a miniaturistic jar (slightly flattened). Same vessel of AbT.14.242.42.

AbT.14.242.42 - Fig. 7.57

Dimensions: wall th.: 0.4 cm; base diam.: 4 cm; base th.: 0.8 cm.

Clay: outer, inner and fabric colour: 2.5Y 8/2 (pale brown); sand inclusions; medium-high firing temperature.

Description: disk base of a miniaturistic jar. Same vessel of AbT.14.242.41.

Catalogue of US 255 Finds

*Objects***AbT.14.60 - Fig. 7.52**

Description: alabastrine limestone vessel fragment with indentation on the rim.

Dimensions: 3.2x2.2x0.4 cm.

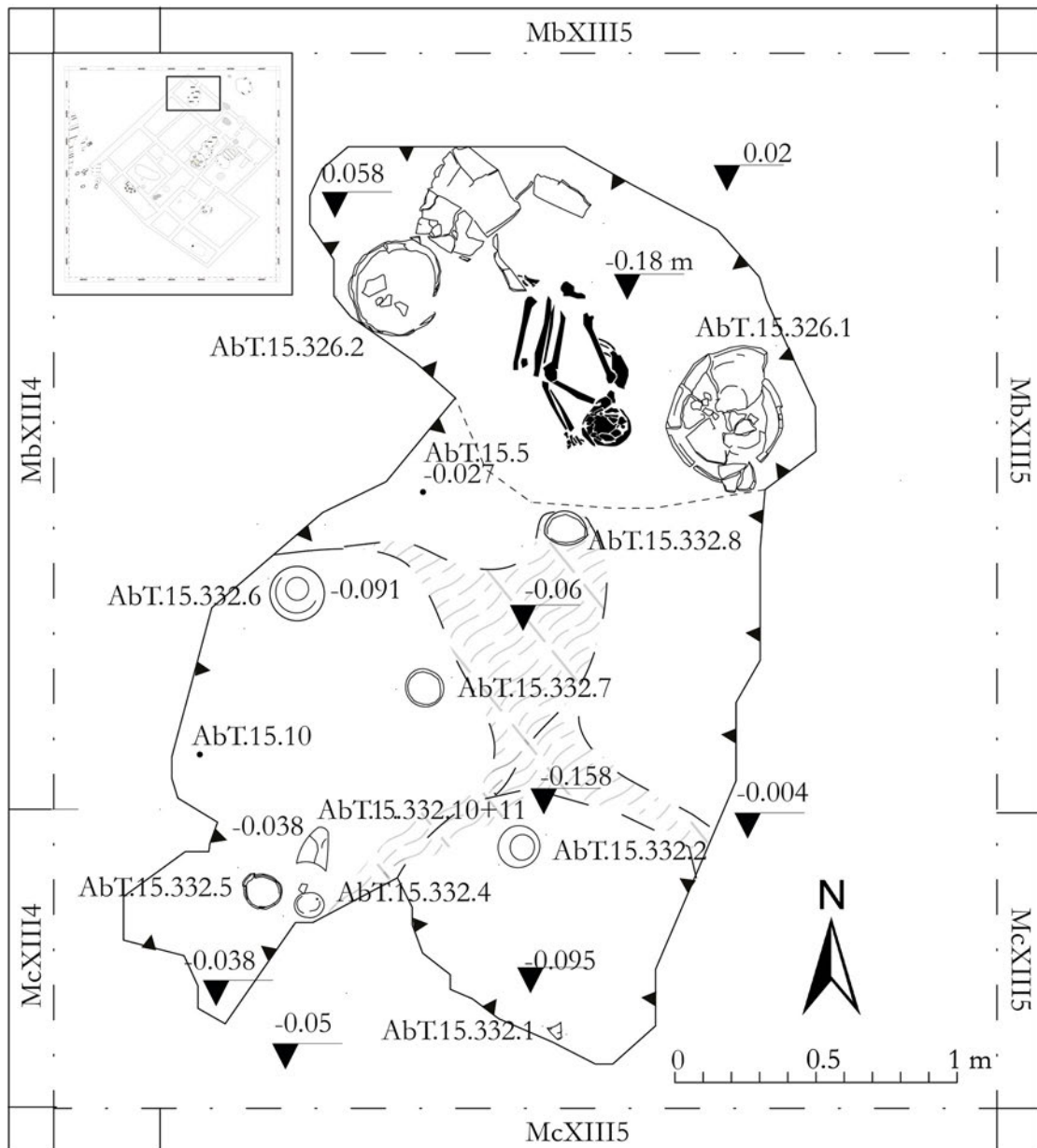

Fig. 7.58 Grave 22 plan (by V. Porzi).

7.3 Mb-CXIII5 [LR]

7.3.1 GRAVE 22 [LR]

The grave (Figs 7.58-60), located in square Mb-cXIII5, cut the complex situation of Rooms 14-15 (see § 8.14). The cut (US 328) was identified at the elevation of 0.02 m, reaching a depth of -0.18 m, and was irregular in shape. The grave was damaged by a gully passing over this part of Area 1:³³ the grave's limits highlighted during the excavation are the combination of the original cut and the erosion caused by rain. The pottery equipment (Fig. 7.61) was indeed scattered irregularly toward

south, sinking in the area in which the soil was more friable.³⁴ Due to the unclear situation, two different US numbers were assigned to the backfill: US 326 to the southern part of the grave's filling; US 332 to the soil covering the equipment near

³³ See Fig. 6.4.

³⁴ It seems that who dug the grave tried to avoid the harder areas constituted by the walls of the underlying building and by the reed structure that was found inside Room 14-15. It should be also considered the possibility of a misinterpretation of the context and that US 326 belonged to the activities inside Room 14-15 (see § 8.14).

the skeleton (US 327 - Fig. 6.60). The filling, in both cases, was constituted by a brown clay soil (slightly lighter for US 332), quite hard and rich of fragments of the hardened clay that surrounded the firing structure of Room 14-15 (§ 8.14).

The skeleton was deposited in fetal position on its left side, with the head toward south and looking west. The left hand was near the face while the legs were bent with the feet toward north (found under AbT.15.326.2). It was apparently wrapped with reed-mat: several fragments were found over and around the bones. The skull was crushed *in situ*. The right arm was placed near the ribs, while radio and ulna flexed on the hips. The body laid between a huge jar flattened on the bottom of the grave's cut and a big bowl.

If we consider the preserved height of the jar (40 cm) some questions should be raised: if the jar was originally in a standing position, as it seems from its base, the cut should be at least 40 cm high, or the jar (and the skull) was immediately broken by the weight of the soil during the filling of the grave. Whatever the right interpretation, it is undeniable that the soil erosion, at least in this part of the area, was considerable and surely cancelled several evidences of occupation of the site.



Fig. 7.59 Grave 22.



Fig. 7.60 Grave 22. Skeleton US 327.



Fig. 7.61 Grave 22 pottery equipment (US 326-332).



Fig. 7.62 US 332 objects.

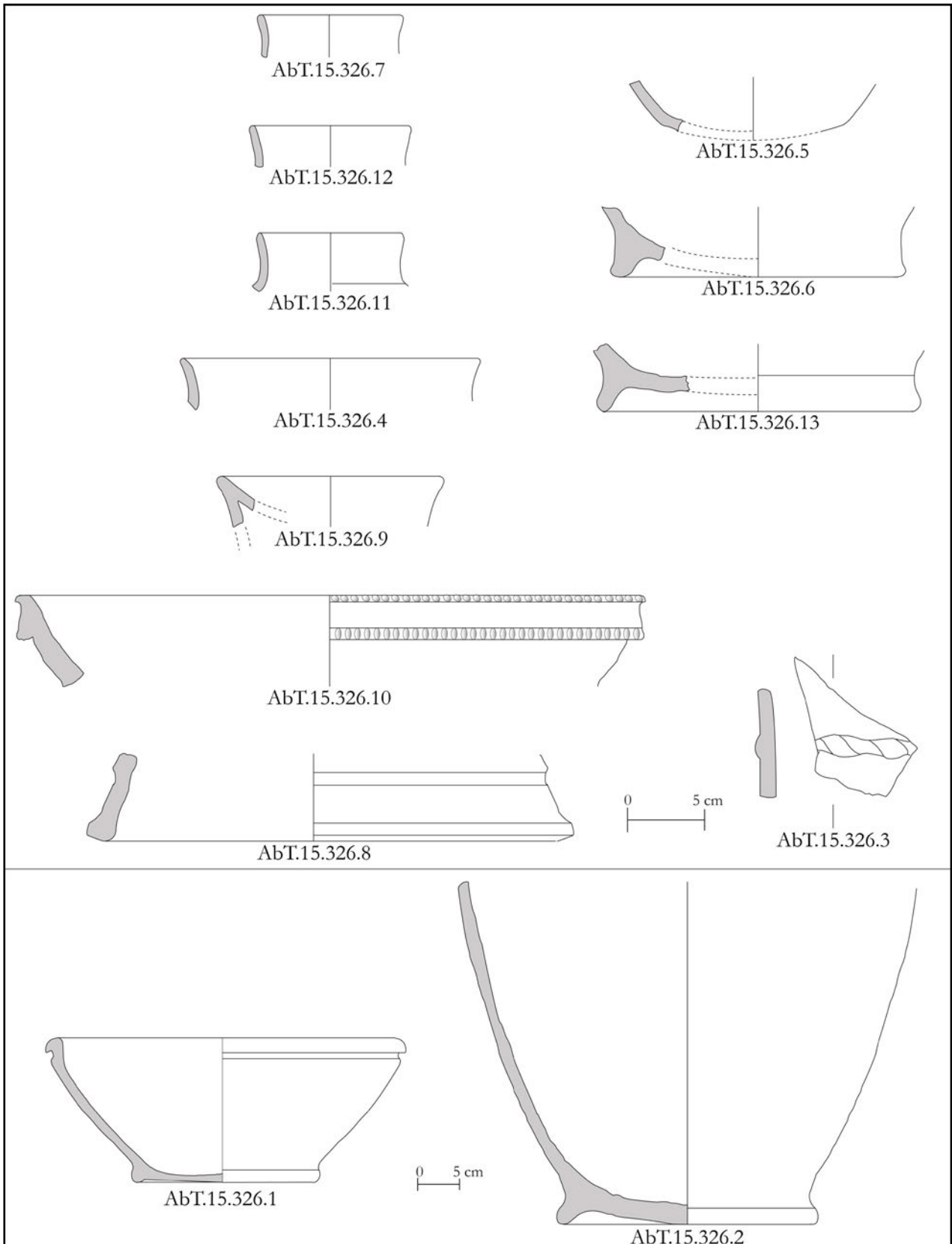

Fig. 7.63 US 326 pottery.

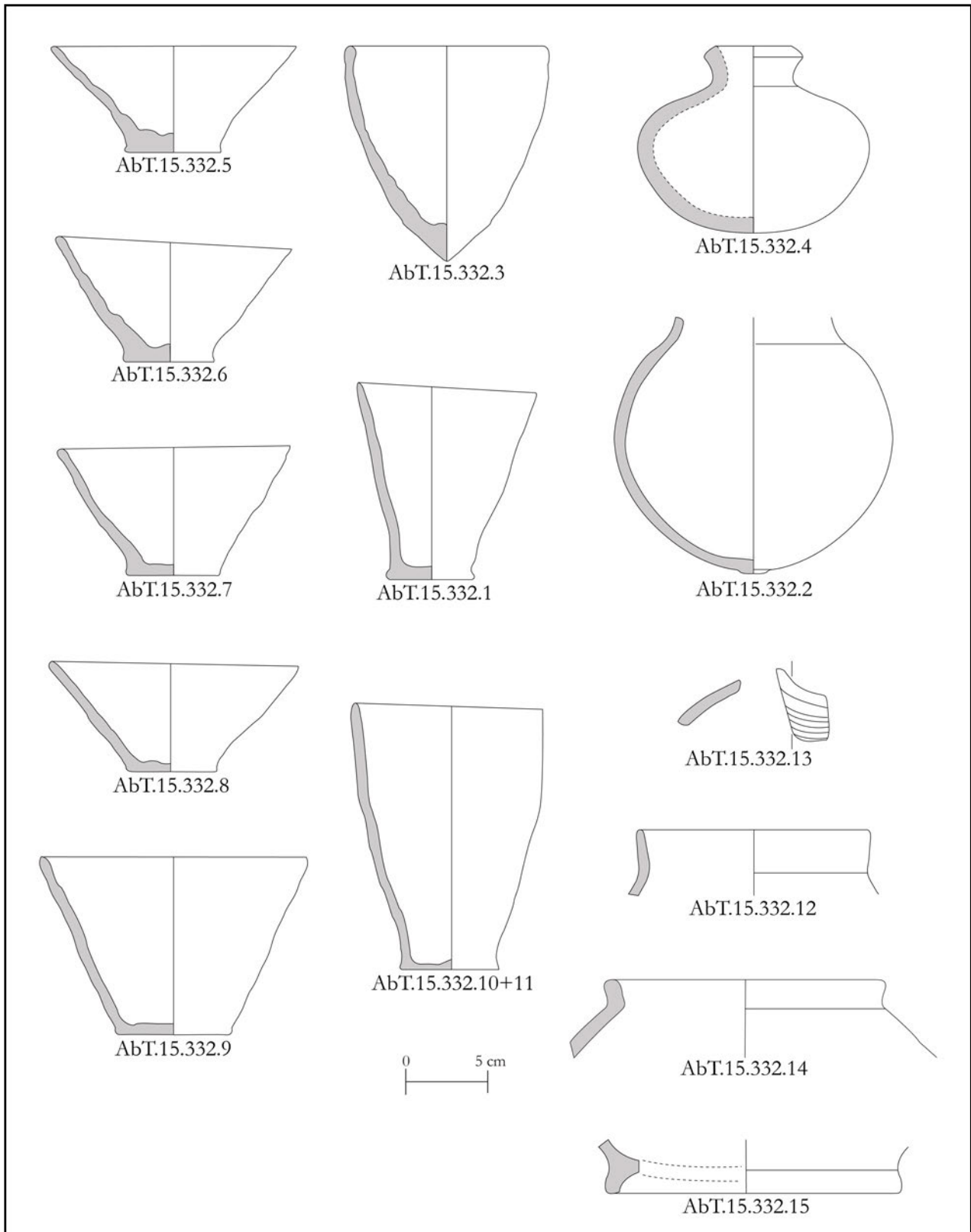

Fig. 7.64 US 332 pottery.

Catalogue of US 326 Finds

*Pottery***AbT.15.326.1 - Fig. 7.63**

Dimensions: rim diam.: 39 cm; rim th.: 2 cm; wall th.: 1 cm; base diam.: 20 cm; base th.: 1 cm; h.: 16.5 cm.

Clay: outer, inner and fabric colour: 2.5Y 7/3 (pale brown); sand inclusions; medium-high firing temperature.

Description: triangular rim bowl with ring base. A groove under the rim.

AbT.15.326.2 - Fig. 7.63

Dimensions: wall th.: 1.5 cm; base diam.: 29 cm; base th.: 2.3 cm.

Clay: outer, inner and fabric colour: 2.5Y 7/3 (pale brown); sand inclusions; medium-high firing temperature.

Description: big coiled ring base jar.

AbT.15.326.3 - Fig. 7.63

Dimensions: wall th.: 0.7 cm.

Clay: outer, inner and fabric colour: 5Y 8/3 (pale yellow); sand inclusions; medium-high firing temperature.

Description: stemmed-dish wall fragment with a notched ridge.

AbT.15.326.4 - Fig. 7.63

Dimensions: rim diam.: 20 cm; rim th.: 0.6 cm; wall th.: 0.6 cm.

Clay: outer and inner colour: 10YR 8/3 (very pale brown); fabric colour: 7.5YR 7/4 (pink); sand inclusions; medium-high firing temperature.

Description: plain rim jar.

AbT.15.326.5 - Fig. 7.63

Dimensions: base diam.: 8 cm; base th.: 1 cm.

Clay: outer and inner colour: 10YR 5/1 (grey); fabric colour: 7.5YR 6/4 (light brown); sand inclusions; medium-high firing temperature.

Description: convex base.

AbT.15.326.6 - Fig. 7.63

Dimensions: wall th.: 0.9 cm; base diam.: 22 cm; base th.: 0.9 cm.

Clay: outer colour: 2.5Y 6/3 (light yellowish brown); inner colour: 7.5YR 4/4 (brown); fabric colour: 7.5YR 6/4 (light brown); sand and vegetal inclusions; medium-low firing temperature.

Description: ring base jar with bitumen traces.

AbT.15.326.7 - Fig. 7.63

Dimensions: rim diam.: 10 cm; rim th.: 0.5 cm; wall th.: 0.4 cm.

Clay: outer and inner colour: 2.5Y 8/2 (pale brown); fabric colour: 7.5YR 7/4 (pink); sand inclusions; medium-high firing temperature.

Description: plain rim jar.

AbT.15.326.8 - Fig. 7.63

Dimensions: wall th.: 1.1 cm; base diam.: 32 cm; base th.: 2.2 cm.

Clay: outer and inner colour: 7.5YR 8/4 (pink); fabric colour: 7.5YR 6/4 (light brown); sand inclusions; medium-low firing temperature.

Description: stemmed-dish base with a ridge on the wall.

AbT.15.326.9 - Fig. 7.63

Dimensions: rim diam.: 14 cm; rim th.: 1.3 cm; wall th.: 0.9 cm.

Clay: outer colour: 7.5YR 8/4 (pink); inner and fabric colour: 5YR 7/6 (reddish yellow); sand inclusions; medium-low firing temperature.

Description: conical bowl attached to a stand.

AbT.15.326.10 - Fig. 7.63

Dimensions: rim diam.: 10 cm; rim th.: 1.1 cm; wall th.: 1.5 cm.

Clay: outer and inner colour: 10YR 7/3 (very pale brown); fabric colour: 10YR 5/3 (brown); sand inclusions; medium-high firing temperature.

Description: stemmed-dish with double ridged rim and notched decoration.

AbT.15.326.11 - Fig. 7.63

Dimensions: rim diam.: 9 cm; rim th.: 0.6 cm; wall th.: 0.6 cm.

Clay: outer colour: 10YR 7/3 (very pale brown); inner colour: 5Y 8/3 (pale yellow); fabric colour: 2.5Y 8/3 (pale brown); sand inclusions; medium-high firing temperature.

Description: plain rim jar.

AbT.15.326.12 - Fig. 7.63

Dimensions: rim diam.: 10 cm; rim th.: 0.5 cm; wall th.: 0.4 cm.

Clay: outer, inner and fabric colour: 2.5Y 8/2 (pale brown); sand inclusions; medium-high firing temperature.

Description: plain rim jar.

AbT.15.326.13 - Fig. 7.63

Dimensions: wall th.: 1.1 cm; base diam.: 20 cm; base th.: 1.5 cm.

Clay: outer colour: 10YR 8/3 (very pale brown); inner and fabric colour: 7.5YR 7/4 (pink); sand and vegetal inclusions; medium-low firing temperature.

Description: ring base.

Catalogue of US 332 Finds

*Objects***AbT.15.5 - Fig. 7.62**

Description: chert blade.

Dimensions: 1.5x3x0.4 cm.

AbT.15.10 - Fig. 7.62

Description: copper alloy point.

Dimensions: 0.6x5.7x0.5 cm.

*Pottery***AbT.15.332.1 - Fig. 7.64**

Dimensions: rim diam.: 11.5 cm; rim th.: 0.5 cm; wall th.: 0.7 cm; base diam.: 4.5 cm; base th.: 1.5 cm; h.: 11 cm.

Clay: outer and inner colour: 5Y 8/4 (pale yellow); sand inclusions; medium-high firing temperature.

Description: beaker.

AbT.15.332.2 - Fig. 7.64

Dimensions: wall th.: 0.7 cm; base diam.: 1.5 cm; base th.: 0.9 cm.

Clay: outer and fabric colour: 7.5YR 7/4 (pink); sand inclusions; medium-low firing temperature.

Description: jar with globular body and small disk base.

AbT.15.332.3 - Fig. 7.64

Dimensions: rim diam.: 11 cm; rim th.: 0.7 cm; wall th.: 0.7 cm; base diam.: 5.3 cm; base th.: 1.5 cm; h.: 13.5 cm.

Clay: outer colour: 7.5YR 7/4 (pink); inner colour: 10YR 6/3 (pale brown); fabric colour: 5YR 5/4 (reddish brown); sand inclusions; medium-low firing temperature.

Description: pointed beaker.

AbT.15.332.4 - Fig. 7.64

Dimensions: rim diam.: 3.4 cm; rim th.: 1 cm; wall th.: 0.8 cm; base diam.: 8.6 ca. cm; h.: 11.9 cm.

Clay: outer colour: 5YR 7/4 (pink); sand inclusions; medium-low firing temperature.

Description: small bottle with triangular rim. Bitumen traces around the rim and the neck.

AbT.15.332.5 - Fig. 7.64

Dimensions: rim diam.: 14.5 cm; rim th.: 0.7 cm; wall th.: 0.8 cm; base diam.: 5.5 cm; base th.: 1.5 cm; h.: 7 cm.
Clay: outer and inner colour: 5YR 6/6 (reddish yellow); sand inclusions; medium-low firing temperature.
Description: conical bowl.

AbT.15.332.6 - Fig. 7.64

Dimensions: rim diam.: 15 cm; rim th.: 0.8 cm; wall th.: 0.8 cm; base diam.: 6 cm; base th.: 1.4 cm; h.: 7.2 cm.
Clay: outer and inner colour: 2.5Y 7/3 (pale brown); sand inclusions; medium firing temperature.
Description: conical bowl with bitumen inside.

AbT.15.332.7 - Fig. 7.64

Dimensions: rim diam.: 14 cm; rim th.: 0.6 cm; wall th.: 0.8 cm; base diam.: 5 cm; base th.: 1 cm; h.: 8 cm.
Clay: outer and inner colour: 2.5Y 7/3 (pale brown); sand inclusions; medium firing temperature.
Description: conical bowl with burning traces.

AbT.15.332.8 - Fig. 7.64

Dimensions: rim diam.: 15.2 cm; rim

th.: 0.7 cm; wall th.: 0.8 cm; base diam.: 4.5 cm; base th.: 0.8 cm; h.: 6.5 cm.
Clay: outer and inner colour: 7.5YR 7/4 (pink); sand inclusions; medium-low firing temperature.
Description: conical bowl.

AbT.15.332.9 - Fig. 7.64

Dimensions: rim diam.: 12.5 cm; rim th.: 0.7 cm; wall th.: 0.7 cm; base diam.: 7 cm; base th.: 1 cm; h.: 10.6 cm.
Clay: outer, inner and fabric colour: 2.5Y 7/3 (pale brown); sand inclusions; medium firing temperature.
Description: conical bowl.

AbT.15.332.10+11 - Fig. 7.64

Dimensions: rim diam.: 11.6 cm; rim th.: 0.5 cm; wall th.: 0.5 cm; base diam.: 5.4 cm; base th.: 1 cm; h.: 16 cm.
Clay: outer and inner colour: 2.5Y 8/3 (pale brown); sand inclusions; medium-high firing temperature.
Description: beaker.

AbT.15.332.12 - Fig. 7.64

Dimensions: rim diam.: 14 cm; rim th.: 0.5 cm; wall th.: 0.6 cm.
Clay: outer and inner colour: 2.5Y 8/4 (pale brown); fabric colour: 5Y 7/1 (light grey); sand inclusions; medium-

high firing temperature.
Description: plain rim jar.

AbT.15.332.13 - Fig. 7.64

Dimensions: wall th.: 0.6 cm.
Clay: outer ("reserved slip like" effect) and inner colour: 5Y 8/3 (pale yellow); fabric colour: 5Y 7/2 (light grey); sand inclusions; medium-high firing temperature.
Description: jar shoulder fragment with combed incisions.

AbT.15.332.14 - Fig. 7.64

Dimensions: rim diam.: 13 cm; rim th.: 1.2 cm; wall th.: 0.7 cm.
Clay: outer and inner colour: 7.5YR 6/4 (light brown); fabric colour: 5YR 6/6 (reddish yellow); sand inclusions; medium-low firing temperature.
Description: plain rim jar.

AbT.15.332.15 - Fig. 7.64

Dimensions: wall th.: 0.7 cm; base diam.: 15 cm; base th.: 1 cm.
Clay: outer colour: 2.5Y 8/2 (pale brown); inner and fabric colour: 7.5YR 7/4 (pink); sand inclusions; medium firing temperature.
Description: ring base.

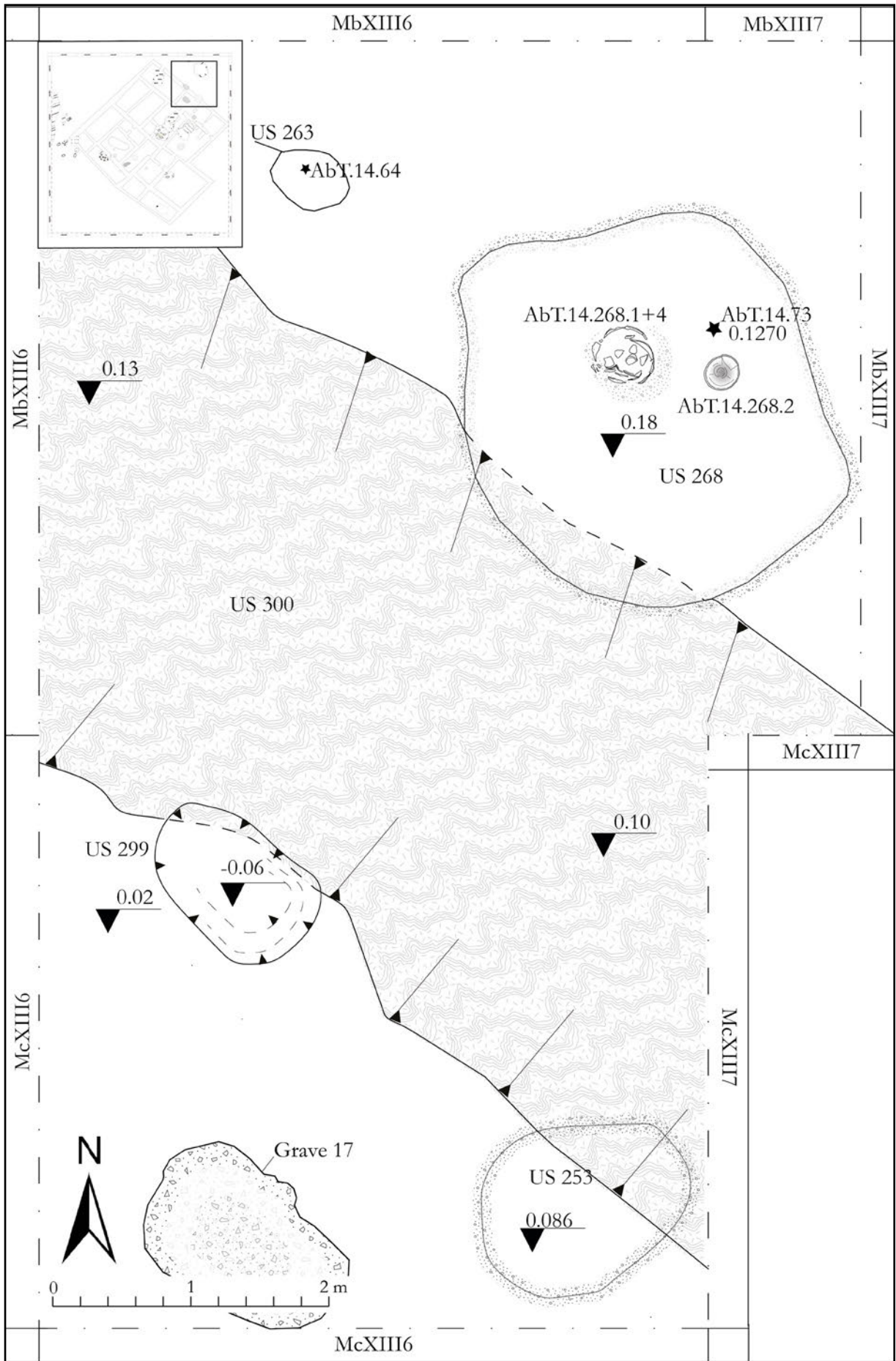

Fig. 7.65 Plan of the activities in Mb-dXIII6-7.

7.4 MB-DXIII6-7 [LR]

7.4.1 OTHER ACTIVITIES [LR]

A rainfall gully was clearly visible in this area (Fig. 7.65 and 6.4) and the excavation revealed a seasonal accumulation stratum formed by alternating lens of greyish and yellowish soil (US 300; elevation 0.13 m).³⁵ The rain was probably eased to flow here because of the presence of a street/corridor separating the underlying Building A from the huge building with stores (?) visible to the north-east.³⁶

North of US 300 other two different activities were recognized during the surface clearance. The first one is a small pit (US 263; cut 264) identified at the elevation of 0.2 m and reaching a depth of 0.05 m. The pit was filled by a quite hard yellowish brown silty-clay soil with few pottery fragments, mostly belonging to drinking vessels.³⁷

A soil heap (US 268) located between MbXIII6 and MbXIII7 was partially eroded, hardened by the flowing of water and by the accumulation of salt crystals. The hard, pale-brown clay soil was rich with pottery fragments, that were contained mainly inside the ring base jar AbT.14.268.1 (Fig. 7.66-67). The jar was probably reused, a clear evidence of the fact that pottery was not disposable: the ring base, indeed, was broken and repaired adding in the middle a disk of re-shaped coarse pottery. The presence of a stemmed-dish base, found upside-down and reveted with a vegetal twine apparently glued with bitumen (Fig. 7.68), is also noteworthy.³⁸

³⁵ If not necessary we avoid to assign a separate US number to the erosion and to its backfill, like in this case. US 300 should be considered as indicating both the negative US and its filling. US 300 was not completely excavated.

³⁶ The presence of the mud-bricks and, thus, the harder consistence of the clay of the building material (if compared to Abu Tbeirah soil) allowed the flowing of rainfall water: the same situation was highlighted in the Harbor (Area 5) where the rainfall water was canalized in correspondance of the entrances from the city to the Harbor complex (see D'Agostino - Romano 2018).

³⁷ Only 7 jar fragments were recovered.

³⁸ Comparison in Schwartz - Hollander 2000: 86 Fig. 3 from Acinebi Tepe (interpreted as a basket impression - bitumen used for waterproofing).

South of US 300, in the north-western part of McXIII6, the seasonal accumulation layers covered a pit (US 298; cut 299), the upper edge of which was identified at the elevation of 0.02 m and reached a depth of -0.06 m. The soil filling the pit consisted in a quite hard dark yellowish-brown clay soil with few pottery fragments, mainly of drinking vessels and of some jars. In the south-west part of McXIII6, US 300 covered a soil heap, US 253, found at the elevation of 0.086 m. The heap, consisting of a quite hard, brown and silty-clay soil, was originally believed to be connected to a grave with sarcophagus due to the presence of some fragments of coarse pottery scattered on its surface.



Fig. 7.66 US 268 pottery.



Fig. 7.67 US 268 pottery: detail of the ring base repaired with a reshaped pottery disk.



Fig. 7.68 Vegetal twine found inside AbT.14.268.2.

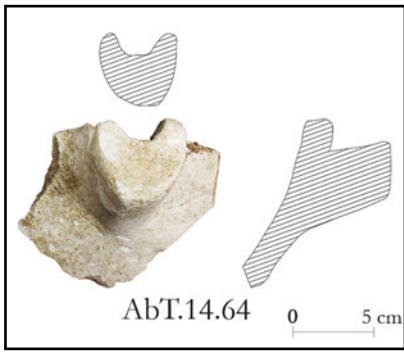

Fig. 7.69 US 263 objects.

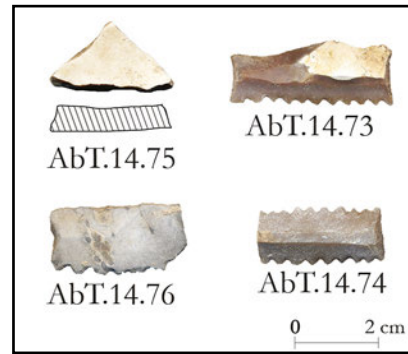

Fig. 7.70 US 268 objects.

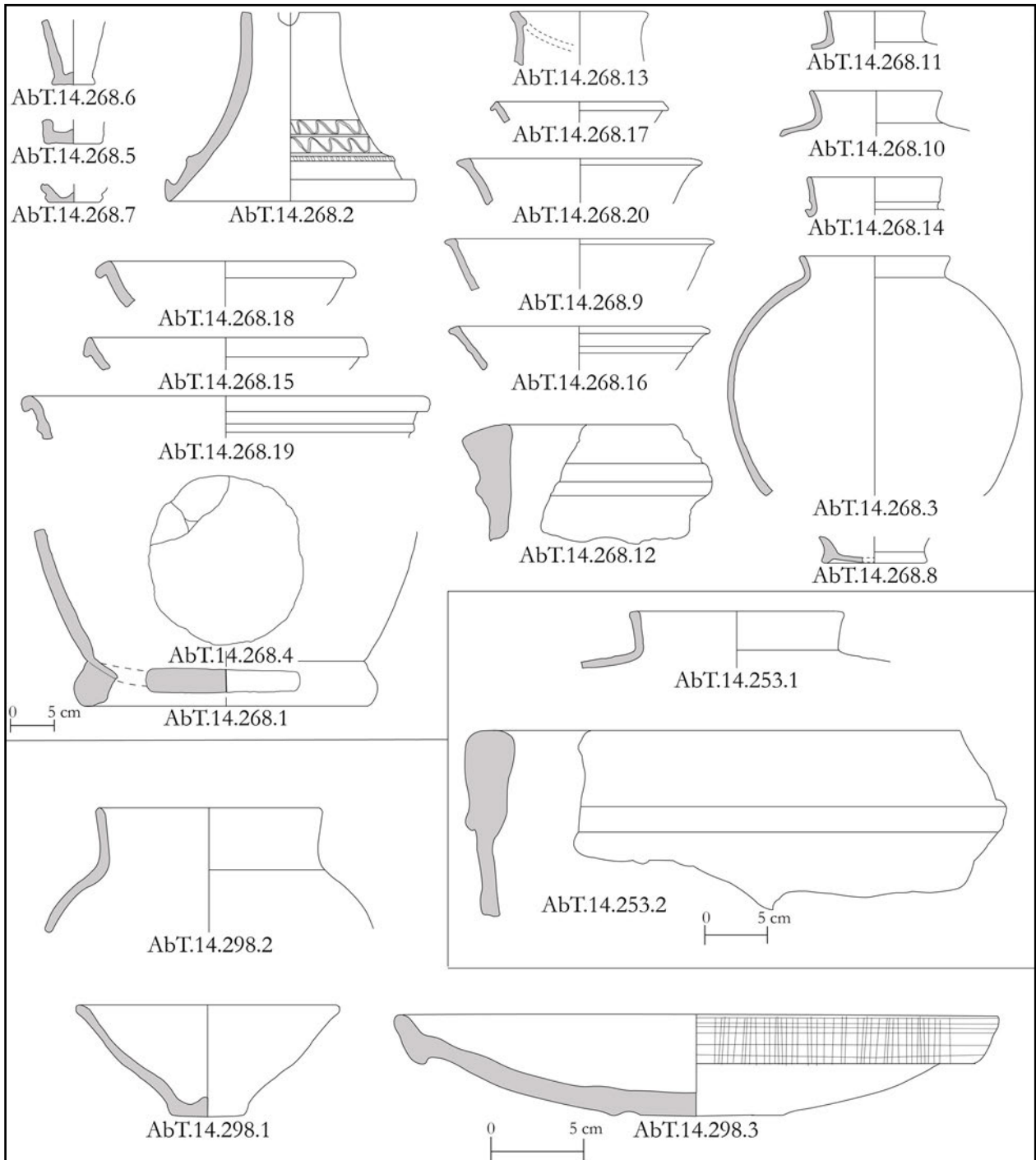

Fig. 7.71 US 253, US 268 and US 298 pottery.

Catalogue of US 253 Finds

*Pottery***AbT.14.253.1 - Fig. 7.71**

Dimensions: rim diam.: 16 cm; rim th.: 0.7 cm; wall th.: 1.1 cm.

Clay: outer and inner colour (slipped): 2.5Y 8/3 (pale brown); fabric colour: 5YR 7/4 (pink); sand inclusions; medium firing temperature.

Description: plain rim jar.

AbT.14.253.2 - Fig. 7.71

Dimensions: rim diam.: n.d.; rim th.: 3.9 cm; wall th.: 1.3 cm.

Clay: outer, inner and fabric colour: 5Y 7/2 (light grey); sand and vegetal inclusions; high firing temperature.

Description: rim and part of the wall of a vat.

Catalogue of US 263 Finds

*Objects***AbT.14.64 - Fig. 7.69**

Description: limestone spouted vessel.
Dimensions: 8.3x13.2x5.9 cm.

Catalogue of US 268 Finds

*Objects***AbT.14.73 - Fig. 7.70**

Description: chert sickle element.
Dimensions: 3.9x1.9x0.4 cm.

AbT.14.74 - Fig. 7.70

Description: chert sickle element.
Dimensions: 3x1.3x0.3 cm.

AbT.14.75 - Fig. 7.70

Description: limestone vessel fragment.
Dimensions: 3.1x1x0.5 cm.

AbT.14.76 - Fig. 7.70

Description: chert sickle element.
Dimensions: 3.4x2.8x0.3 cm.

*Pottery***AbT.14.268.1 - Fig. 7.71**

Dimensions: wall th.: 1 cm; base diam.: 32 cm; base th.: 2.3 cm.

Clay: outer, inner and fabric colour: 5YR 5/6 (yellowish red); sand inclusions; medium firing temperature.
Description: ring base jar. The base

was repaired with a disk made of a very coarse wall reshaped in the form of a disk (AbT.14.268.4).

AbT.14.268.2 - Fig. 7.71

Dimensions: wall th.: 1.2 cm; base diam.: 25 cm; base th.: 1.7 cm.

Clay: outer, inner and fabric colour: 5YR 6/6 (reddish yellow); sand inclusions; medium firing temperature.
Description: stemmed-dish base. The bottom of two rounded openings is preserved near the upper fracture of the base. Notched ridge immediately over the beginning of the base and weavy incisions over the ridge.

AbT.14.268.3 - Fig. 7.71

Dimensions: rim diam.: 15 cm; rim th.: 0.7 cm; wall th.: 0.8 cm.

Clay: outer, inner and fabric colour: 10YR 7/3 (very pale brown); sand inclusions; medium firing temperature.
Description: plain rim jar with globular body.

AbT.14.268.4 - Fig. 7.71

Dimensions: base diam.: 17.5 cm; base th.: 2.8 cm.

Clay: outer colour: 5Y 7/3 (pale yellow); inner colour: 2.5Y 6/4 (light yellowish brown); fabric colour: 5Y 6/3 (pale olive); sand and vegetal inclusions; high firing temperature.

Description: very coarse pottery disk, obtained reshaping a wall of a vat and reused with AbT.14.268.1.

AbT.14.268.5 - Fig. 7.71

Dimensions: wall th.: 1.3 cm; base diam.: 5.9 cm; base th.: 1.2 cm.

Clay: outer, inner and fabric colour: 2.5Y 8/3 (pale brown); sand inclusions; medium-high firing temperature.
Description: drinking vessel base.

AbT.14.268.6 - Fig. 7.71

Dimensions: wall th.: 0.7 cm; base diam.: 4.5 cm; base th.: 1 cm.

Clay: outer, inner and fabric colour: 2.5YR 5/4 (reddish brown); sand inclusions; medium-low firing temperature.

Description: beaker base.

AbT.14.268.7 - Fig. 7.71

Dimensions: base diam.: 6 cm; base th.: 0.5 cm.

Clay: outer, inner and fabric colour:

5YR 7/4 (pink); sand inclusions; medium-low firing temperature.

Description: conical bowl base.

AbT.14.268.8 - Fig. 7.71

Dimensions: base diam.: 11 cm; base th.: 0.5 cm.

Clay: outer, inner and fabric colour: 5YR 6/4 (5YR 6/4); sand inclusions; medium-low firing temperature.
Description: ring base.

AbT.14.268.9 - Fig. 7.71

Dimensions: rim diam.: 26 cm; rim th.: 1.4 cm; wall th.: 0.8 cm.

Clay: outer, inner and fabric colour: 5YR 7/4 (pink); sand inclusions; medium-low firing temperature.
Description: triangular rim bowl.

AbT.14.268.10 - Fig. 7.71

Dimensions: rim diam.: 13 cm; rim th.: 0.6 cm; wall th.: 0.6 cm.

Clay: outer colour: 2.5Y 8/2 (pale brown); inner colour: 7.5YR 6/4 (light brown); fabric colour: 5YR 6/4 (light reddish brown); sand inclusions; medium firing temperature.
Description: plain rim jar.

AbT.14.268.11 - Fig. 7.71

Dimensions: rim diam.: 10 cm; rim th.: 0.5 cm; wall th.: 0.6 cm.

Clay: outer colour: 2.5Y 8/2 (pale brown); inner colour: 10YR 7/3 (very pale brown); fabric colour: 7.5YR 7/3 (pink); sand inclusions; medium firing temperature.

Description: plain rim jar.

AbT.14.268.12 - Fig. 7.71

Dimensions: rim diam.: n.d.; rim th.: 5.6 cm; wall th.: 2.2 cm.

Clay: outer, inner and fabric colour: 5Y 8/4 (pale yellow); sand and vegetal inclusions; high firing temperature.

Description: double-ridged rim of a vat.

AbT.14.268.13 - Fig. 7.71

Dimensions: rim diam.: 13 cm; rim th.: 1.2 cm; wall th.: 0.9 cm.

Clay: outer colour: 10YR 8/3 (very pale brown); inner colour: 7.5YR 7/4 (pink); fabric colour: 5YR 6/6 (reddish yellow); sand inclusions; medium firing temperature.

Description: conical bowl attached to a stand.

AbT.14.268.14 - Fig. 7.71

Dimensions: rim diam.: 13.5 cm; rim th.: 0.6 cm; wall th.: 0.8 cm.

Clay: outer, inner and fabric colour: 5Y 7/3 (pale yellow); sand inclusions; medium-high firing temperature.

Description: band rim jar.

AbT.14.268.15 - Fig. 7.71

Dimensions: wall th.: 0.9 cm; base diam.: 28 cm; base th.: 0.9 cm.

Clay: outer, inner and fabric colour: 7.5YR 6/4 (light brown); sand inclusions; medium firing temperature.

Description: triangular rim bowl.

AbT.14.268.16 - Fig. 7.71

Dimensions: rim diam.: 25 cm; rim th.: 1.1 cm; wall th.: 0.8 cm.

Clay: outer, inner and fabric colour: 2.5Y 8/2 (pale brown); sand inclusions; medium firing temperature.

Description: triangular rim bowl. Applied ridge on the wall.

AbT.14.268.17 - Fig. 7.71

Dimensions: rim diam.: 17 cm; rim th.: 1.2 cm; wall th.: 0.7 cm.

Clay: outer, inner and fabric colour: 2.5Y 8/2 (pale brown); sand inclusions; medium-high firing temperature.

Description: triangular rim bowl.

AbT.14.268.18 - Fig. 7.71

Dimensions: wall th.: 1.2 cm; base diam.: 24 cm; base th.: 2 cm.

Clay: outer, inner and fabric colour: 10YR 8/3 (very pale brown); sand inclusions; medium firing temperature.

Description: triangular rim bowl.

AbT.14.268.19 - Fig. 7.71

Dimensions: rim diam.: 34 cm; rim th.: 1.9 cm; wall th.: 1.2 cm.

Clay: outer, inner and fabric colour: 10YR 8/2 (very pale brown); sand inclusions; medium-high firing temperature.

Description: triangular rim bowl.

AbT.14.268.20 - Fig. 7.71

Dimensions: rim diam.: 23 cm; rim th.: 1.3 cm; wall th.: 1 cm.

Clay: outer, inner and fabric colour: 7.5YR 8/2 (pinkish white); sand inclusions; medium-high firing temperature.

Description: triangular rim bowl.

Catalogue of US 298 Finds

*Pottery***AbT.14.298.1 - Fig. 7.71**

Dimensions: rim diam.: 14 cm; rim th.: 0.7 cm; wall th.: 0.9 cm; base diam.: 5

cm; base th.: 0.7 cm; h.: 6.7 cm.

Clay: outer, inner and fabric colour: 2.5Y 8/2 (pale brown); sand inclusions; medium-high firing temperature.

Description: conical bowl.

AbT.14.298.2 - Fig. 7.71

Dimensions: rim diam.: 12 cm; rim th.: 0.5 cm; wall th.: 0.5 cm.

Clay: outer, inner and fabric colour: 5YR 5/6 (yellowish red); sand inclusions; medium-low firing temperature.

Description: plain rim jar.

AbT.14.298.3 - Fig. 7.71

Dimensions: rim diam.: 31 cm; rim th.: 1.2 cm; wall th.: 1.2 cm; base diam.: 5.9 cm; base th.: 1.3 cm; h.: 5.5 cm.

Clay: outer and inner colour (self-slip): 2.5Y 8/3 (pale brown); fabric colour: 5YR 6/4 (light reddish brown); sand inclusions; medium firing temperature.

Description: stemmed-dish bowl (probably reused once detached from the stem). Incised grid-like decoration on the rim.

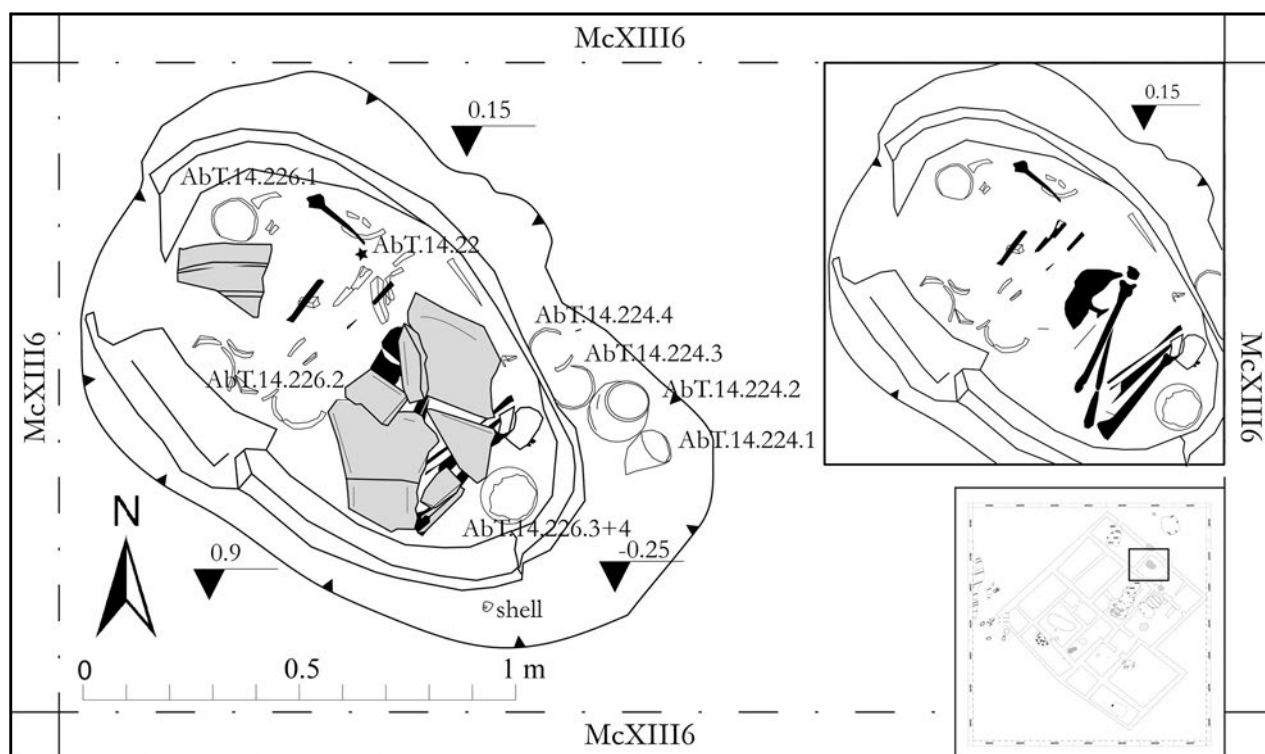

Fig. 7.72 Grave 17 plan (realized by C. Rielli).

7.4.2 GRAVE 17 [LR]

In McXIII6, at the elevation of 0.15 m, another sarcophagus was discovered, already looted in antiquity (cut US 231, filling US 226 - Figs 7.72-75). The cut of the grave destroyed the stratigraphy of Room 8 (see § 8.8) reaching the elevation of -0.25 m at its bottom. The evidence suggests that the ancient looters opened the grave digging directly inside it, in correspondence of the sarcophagus' limits. No other cut was visible than the one made to host the coffin. The sarcophagus US 225 was realized in a reddish-yellow coarse pottery, with an out-turned and flattened rim, three ridges on the wall and a oval ring base. The coffin broke down during or after firing, the fracture was then fixed with bitumen (see Fig. 7.74). The weight of the soil and the looting left the coffin in fragments. The compact, pale brown, and silty soil filling the robber's hole (US 226) was rich in pottery fragments and covered part of the pottery equipment (same US).³⁹ However, some of the vessels inside the coffin were preserved: a jar with a conical bowl used as lid near the feet; a conical bowl near the

right hip, but moved from its original position; a small beaker found in correspondence of the skull. The skeleton (US 237- Fig. 7.73) was badly preserved only in its lower part. The body was apparently oriented north-west/south-east. The hips, found crushed one over the other, were in a very bad state of preservation. Few other bones were scattered inside US 226. The quite hard, pale brown silty soil (US 224) between the coffin and the cut of the grave (US 230) covered 3 beakers and one jar (AbT.14.226.1-4), located east of the coffin. Fragments of two different limestone vessels were found in US 224 and US 226.

³⁹ In addition to the pottery in the catalogue the following pieces have been found: 2 drinking vessel bases; 1 rounded rim jar fragment; 1 band rim jar fragment.



Fig. 7.73 Grave 17 coffin (US 225).

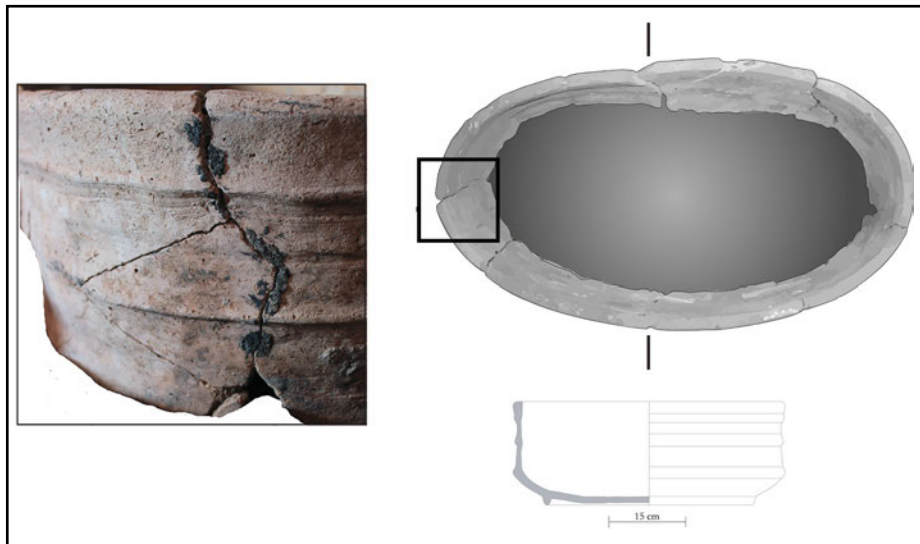

Fig. 7.74 Grave 17 coffin (US 225): drawing and detail of the bitumen repairing.



Fig. 7.75 Grave 17 coffin and equipment.

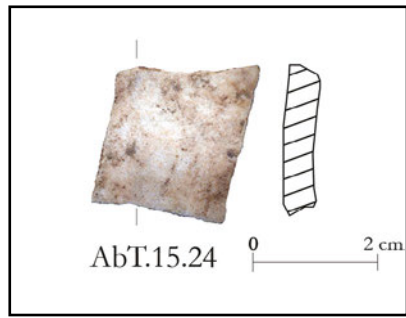

Fig. 7.76 US 224 objects.

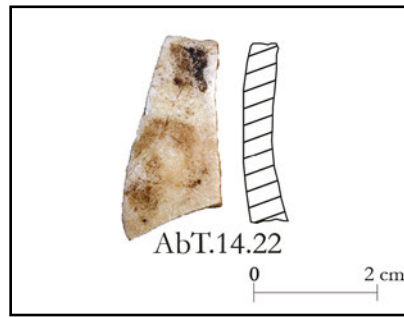

Fig. 7.77 US 226 objects.

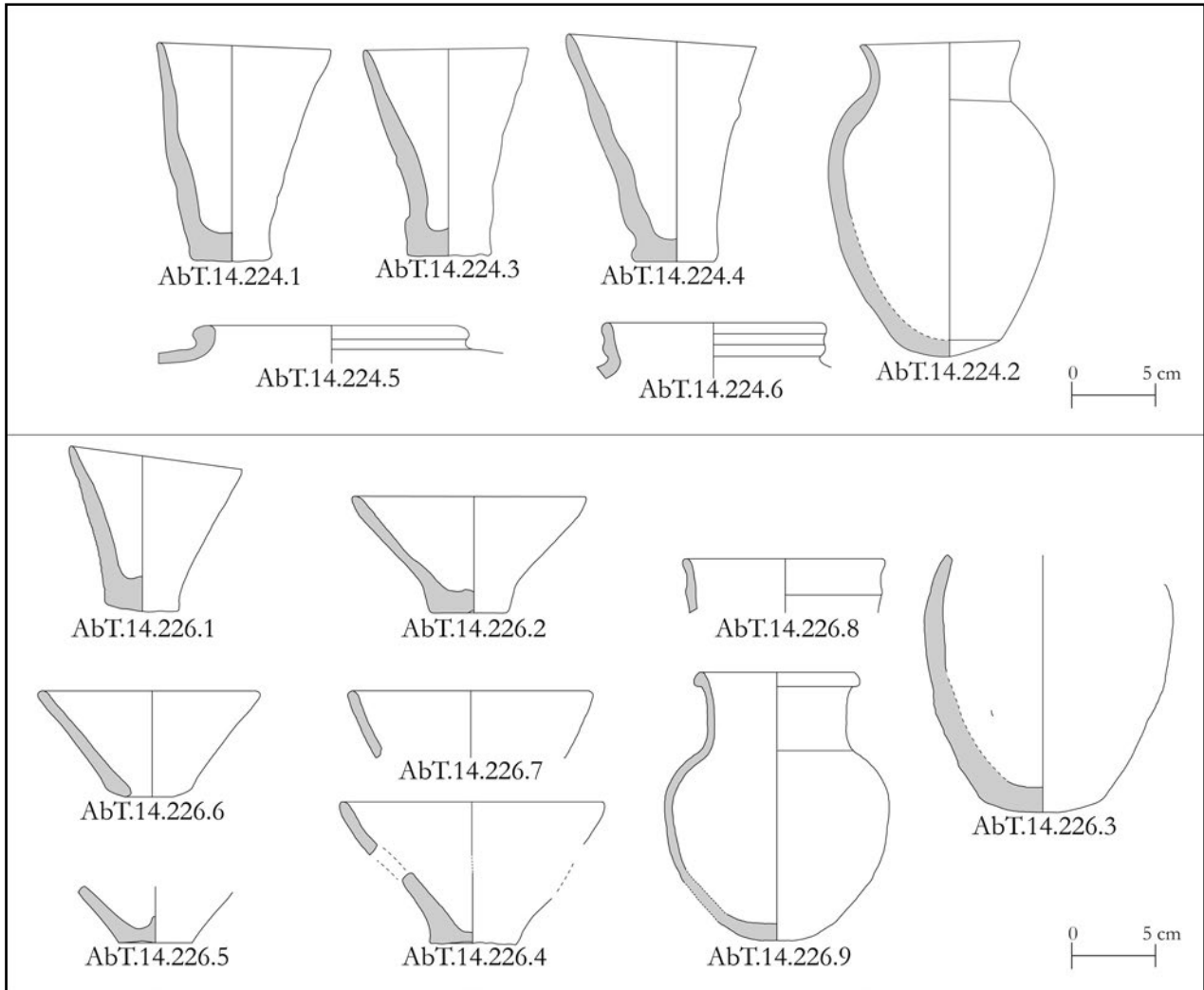

Fig. 7.78 US 224 and US 226 pottery.

Catalogue of US 224 Finds

*Objects***AbT.14.224 - Fig. 7.76**

Description: fragment of a limestone vessel; found near AbT.14.224.3.

Dimensions: 2.3x2.4x0.4 cm.

*Pottery***AbT.14.224.1 - Fig. 7.78**

Dimensions: rim diam.: 11.3 cm; rim th.: 0.5 cm; wall th.: 1.2 cm; base diam.: 1.5 cm; base th.: 5.4 cm; h.: 13.9 cm.

Clay: outer, inner and fabric colour: 5YR 6/4 (light reddish brown); sand inclusions; low firing temperature.

Description: beaker.

AbT.14.224.2 - Fig. 7.78

Dimensions: rim diam.: 10 cm; rim th.: 0.6 cm; wall th.: 1.2 cm; base diam.: 6.5 cm; base th.: 1 cm; h.: 20.5 cm.

Clay: outer, inner and fabric colour: 5YR 7/4 (pink); sand inclusions; medium-low firing temperature.

Description: plain rim jar with convex base.

AbT.14.224.3 - Fig. 7.78

Dimensions: rim diam.: 10.9 cm; rim th.: 0.7 cm; wall th.: 1 cm; base diam.: 5.5 cm; base th.: 1 cm; h.: 13 cm.

Clay: outer, inner and fabric colour: 5YR 7/4 (pink); sand inclusions; low firing temperature.

Description: beaker.

AbT.14.224.4 - Fig. 7.78

Dimensions: rim diam.: 10.7 cm; rim th.: 0.8 cm; wall th.: 0.7 cm; base diam.: 5 cm; base th.: 1.5 cm; h.: 13.5 cm.

Clay: outer, inner and fabric colour: 5YR 7/4 (pink); sand inclusions; low firing temperature.

Description: beaker.

AbT.14.224.5 - Fig. 7.78

Dimensions: rim diam.: 16 cm; rim th.: 1.2 cm; wall th.: 0.8 cm.

Clay: outer, inner and fabric colour: 10YR 8/4 (very pale brown); sand inclusions; medium-high firing temperature.

Description: plain rim jar (almost triangular rim).

AbT.14.224.6 - Fig. 7.78

Dimensions: rim diam.: 13 cm; rim th.: 0.6 cm; wall th.: 0.7 cm.

Clay: outer and inner colour: 10YR 8/4 (very pale brown); fabric colour: 5YR 6/6 (reddish yellow); sand inclusions; medium-high firing temperature.

Description: double-ridged rim jar.

Catalogue of US 225 Finds

*Pottery***AbT.14.225.1**

Dimensions: rim diam. (min): 53 cm; rim th.: 2.3 cm; wall th.: 1.5 cm; base diam.: 40 cm; base th.: 1.2 cm; h.: 23 cm ca.

Clay: outer, inner and fabric colour: 5YR 6/6 (reddish yellow); sand inclusions; medium firing temperature.

Description: coiled coffin with two ridges on the wall and ring base.

Catalogue of US 226 Finds

*Objects***AbT.14.22 - Fig. 7.77**

Description: limestone vessel fragment.

Dimensions: 3.4x1.5x0.5 cm.

*Pottery***AbT.14.226.1 - Fig. 7.78**

Dimensions: rim diam.: 11.3 cm; rim th.: 0.6 cm; wall th.: 1 cm; base diam.: 4.5 cm; base th.: 1 cm; h.: 10.6 cm.

Clay: outer and inner colour: 10YR 8/3 (very pale brown); sand inclusions; medium-high firing temperature.

Description: small beaker.

AbT.14.226.2 - Fig. 7.78

Dimensions: rim diam.: 15.5 cm; rim th.: 0.7 cm; wall th.: 0.8 cm; base diam.: 5.1 cm; base th.: 0.6 cm; h.: 7.3 cm.

Clay: outer, inner and fabric colour: 2.5YR 7/6 (light red); sand inclusions; low firing temperature.

Description: conical bowl.

AbT.14.226.3 - Fig. 7.78

Dimensions: wall th.: 1.1 cm; base diam.: 7.5 cm; base th.: 0.8 cm.

Clay: outer colour (self-slip): 2.5YR 8/3 (pink); inner and fabric colour: 2.5YR

5/6 (red); sand inclusions; medium-high firing temperature.

Description: convex base jar. The conical bowl AbT.14.226.4 was found inside it (lid?).

AbT.14.226.4 - Fig. 7.78

Dimensions: rim diam.: 16 cm; rim th.: 0.8 cm; wall th.: 1.1 cm; base diam.: 5.2 cm; base th.: 1 cm.

Clay: outer, inner and fabric colour: 2.5YR 6/6 (light red); sand inclusions; medium-high firing temperature.

Description: conical bowl found inside AbT.14.226.3 (lid?).

AbT.14.226.5 - Fig. 7.78

Dimensions: wall th.: 1 cm; base diam.: 4.9 cm; base th.: 0.7 cm.

Clay: outer, inner and fabric colour: 7.5YR 7/4 (pink); sand inclusions; medium firing temperature.

Description: conical bowl base.

AbT.14.226.6 - Fig. 7.78

Dimensions: rim diam.: 13 cm; rim th.: 0.7 cm; wall th.: 0.9 cm.

Clay: outer, inner and fabric colour: 2.5YR 6/6 (light red); sand inclusions; medium-high firing temperature.

Description: conical bowl.

AbT.14.226.7 - Fig. 7.78

Dimensions: rim diam.: 14.5 cm; rim th.: 0.6 cm; wall th.: 0.6 cm.

Clay: outer, inner and fabric colour: 2.5YR 6/6 (light red); sand inclusions; low firing temperature.

Description: conical bowl rim.

AbT.14.226.8

Dimensions: rim diam.: 12 cm; rim th.: 0.7 cm.

Clay: outer and inner colour: 7.5YR 8/3 (pink); fabric colour: 2.5YR 7/8 (light red); sand inclusions; low firing temperature.

Description: band rim jar.

AbT.14.226.9

Dimensions: rim diam.: 10 cm; rim th.: 0.7 cm; wall th.: 0.4 cm; base diam.: 5.2 cm; base th.: 0.8 cm; h.: 16 cm ca.

Clay: outer and inner colour: 5YR 8/4 (pink); fabric colour: 2.5YR 5/6 (red); sand inclusions; medium firing temperature.

Description: triangular rim jar.

7.4.3 MdXIII7 [LR]

In square MdXIII7, in correspondance of the northern angle of Room 13, a pit (US 335) was located (see plan at Fig. 8.66), the backfill of which (US 336) was characterized by an olive yellow clay soil, with abundant salt crystals and several bone and pottery fragments. The two fragmentary conical bowl found in the pit were strongly weathered and clearly in secondary context.⁴⁰

Catalogue of US 336 Finds

*Pottery***AbT.15.336.1 - Fig. 7.79**

Dimensions: rim diam.: 11 cm; rim th.: 0.5 cm; wall th.: 0.6 cm; base diam.: 4.6 cm; base th.: 1 cm; h.: 4.2 cm.

Clay: outer colour: 5YR 5/4 (reddish brown); inner colour: 7.5YR 7/4 (pink); fabric colour: 5YR 6/4 (light reddish brown); sand inclusions; medium-low firing temperature.

Description: conical bowl.

AbT.15.336.2 - Fig. 7.79

Dimensions: rim diam.: 13 cm; rim th.: 0.6 cm; wall th.: 0.8 cm; base diam.: 5 cm; base th.: 1.3 cm; h.: 8.2 cm.

Clay: outer and inner colour: 2.5Y 8/2 (pale brown); fabric colour: 5YR 6/4 (light reddish brown); sand inclusions; medium firing temperature.

Description: conical bowl.

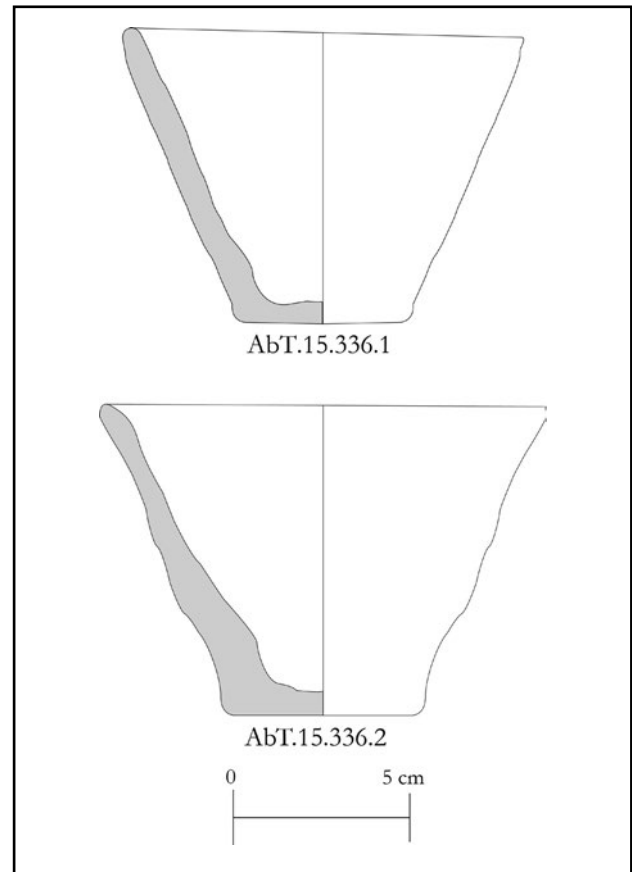

Fig. 7.79 US 336 Pottery.

⁴⁰ In addition to the two conical bowls, fragments of at least two different jars were collected.

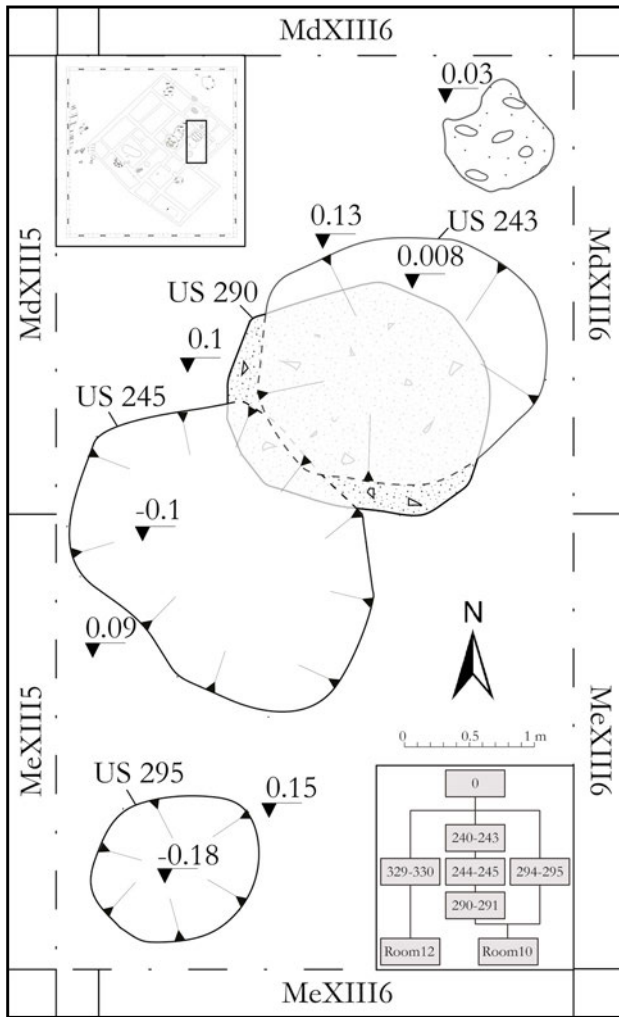

Fig. 7.80 Plan of the activities in MdXIII6+MeXIII5+6.



Fig. 7.81 Bitumen ingot inside US 295.



Fig. 7.82 Spherical bitumen object found inside US 295.

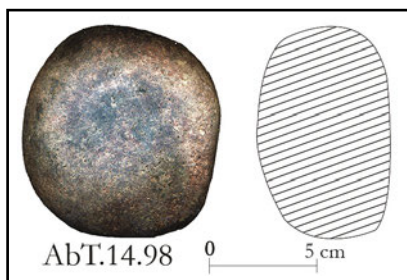

Fig. 7.83 US 294 objects.

7.5 MdXIII6+MeXIII5+6 [LR]

7.5.1 OTHER ACTIVITIES [LR]

In squares MdXIII6+MeXIII5+6 (Fig. 7.80), immediately over Building A Room 10, several pits were identified under the surface, probably connected to the dumping activities that damaged also Room 7.

A group of three pits partially cut the dividing wall between Room 10 and 7, near the northern part of the former. The latest of these activities was a shallow cut (US 243; from 0.13 m to 0.008 m), filled by US 240, consisting of a greyish brown ashy soil. The US contained fragments of a big coiled jar. Most of the other fragments belonged to drinking vessels and jars of medium dimensions. This pit cut the north-east part of the second one: US 244 (cut US 245) was identified at the elevation of 0.09 m, reaching the depth of -0.1 m. The pit was filled by a quite soft, organic and greyish soil, full of pottery fragments (mainly drinking vessels and medium jar walls). US 245 cut the third pit (US 290; cut 291) and found at the elevation of 0.1 m, reaching a depth of -0.24 m. The backfill, a light yellowish-brown clay soil, contained several pieces of an overfired jar and fragments of drinking vessels (at least 5).

In the area corresponding to the south-western part of Room 10, immediately under the surface, a fourth pit was located. The cut (US 295) was identified at the elevation of 0.15 m and reached a depth of -0.18 m. US 294, the quite hard, light yellowish brown, and silty soil filling the pit, contained few fragments of pottery, mostly from drinking vessels. A bitumen “ingot” in fragments was found together with a spherical one (Figs 6.81-82).

In the western corner of Room 12, another shallow pit (US 329; cut 330) cut the underlying strata from the elevation of 0.03 m until a depth of -0.04 m. The pit was filled by a compact, pale yellow clay soil, rich in mud-brick fragments and containing only one complete conical bowl.

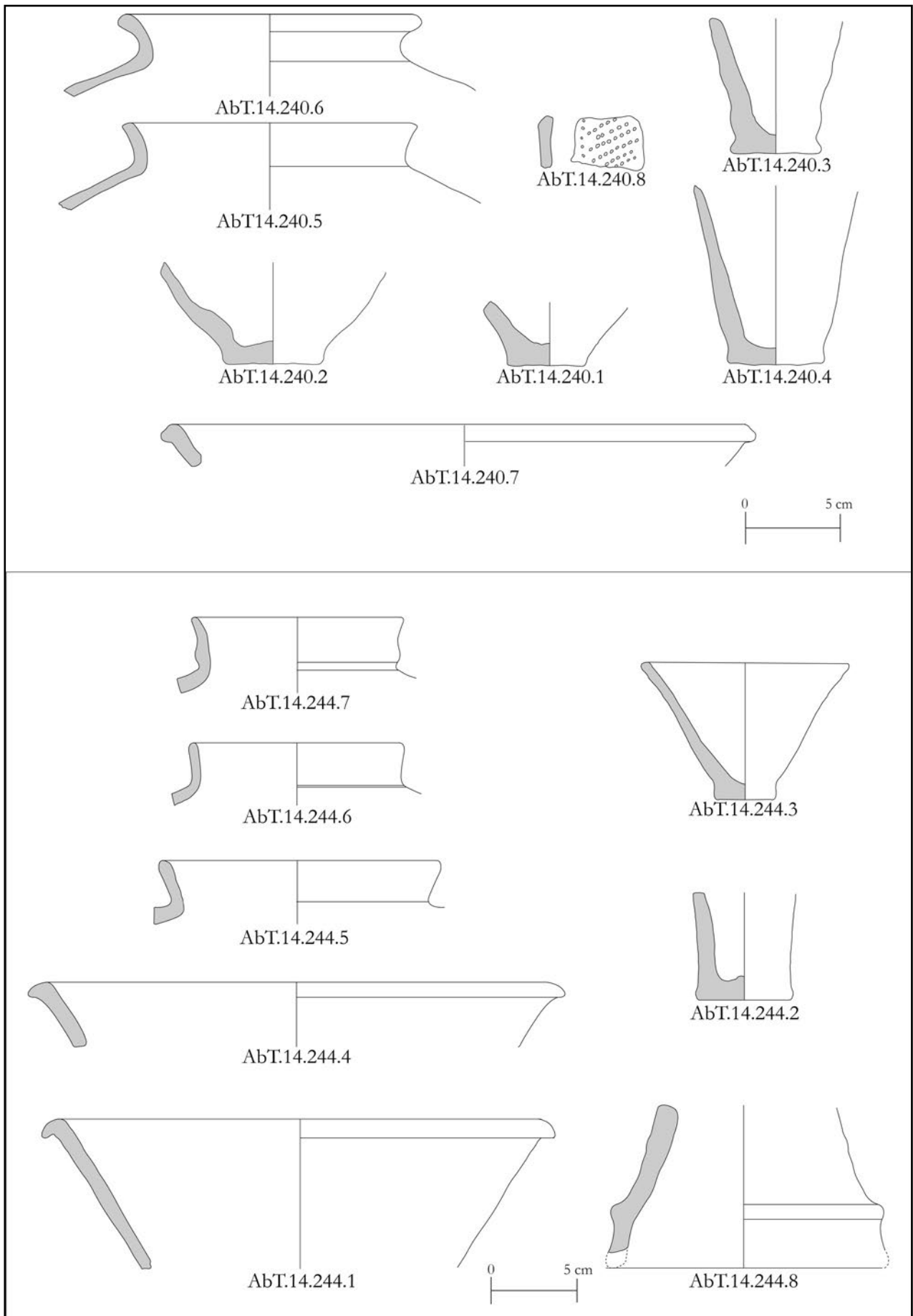

Fig. 7.84 US 240 and US 244 pottery.

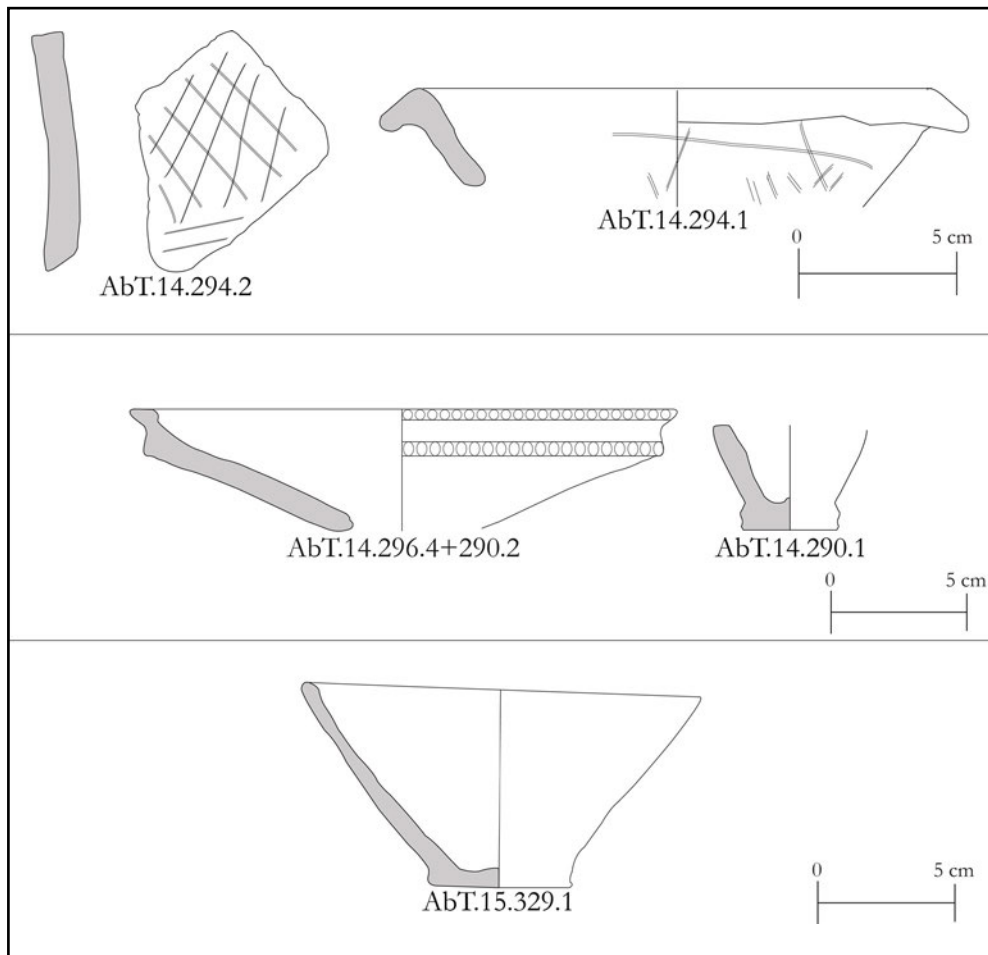

Fig. 7.85 US 290, US 294 and US 329 pottery.

Catalogue of US 240 Finds

*Pottery***AbT.14.240.1 - Fig. 7.84**

Dimensions: wall th.: 0.9 cm; base diam.: 5 cm; base th.: 0.8 cm.
Clay: outer, inner and fabric colour: 5YR 5/6 (yellowish red); sand inclusions; medium-low firing temperature.
Description: conical bowl base.

AbT.14.240.2 - Fig. 7.84

Dimensions: wall th.: 0.7 cm; base diam.: 4.5 cm; base th.: 1 cm.
Clay: outer, inner and fabric colour: 5YR 5/6 (yellowish red); sand inclusions; medium-low firing temperature.
Description: conical bowl base.

AbT.14.240.3 - Fig. 7.84

Dimensions: wall th.: 0.8 cm; base diam.: 5.5 cm; base th.: 1.1 cm.
Clay: outer and inner colour: 10YR 7/4 (very pale brown); fabric colour: 5YR 5/6 (yellowish red); sand inclusions; medium-low firing temperature.
Description: beaker base.

AbT.14.240.4 - Fig. 7.84

Dimensions: wall th.: 0.6 cm; base diam.: 5.3 cm; base th.: 1 cm.
Clay: outer, inner and fabric colour: 5YR 6/6 (reddish yellow); sand inclusions; medium-low firing temperature.
Description: beaker base.

AbT.14.240.5 - Fig. 7.84

Dimensions: rim diam.: 14 cm; rim th.: 0.7 cm; wall th.: 0.7 cm.
Clay: outer, inner and fabric colour: 2.5Y 7/4 (pale brown); sand inclusions; medium firing temperature.
Description: plain rim jar.

AbT.14.240.6 - Fig. 7.84

Dimensions: rim diam.: 14 cm; rim th.: 0.9 cm; wall th.: 0.6 cm.
Clay: outer, inner and fabric colour: 2.5Y 8/3 (pale brown); sand inclusions; medium firing temperature.
Description: plain rim jar.

AbT.14.240.7 - Fig. 7.84

Dimensions: rim diam.: 34 cm; rim th.: 1.2 cm; wall th.: 0.8 cm.
Clay: outer and inner colour: 10YR 7/3 (very pale brown); fabric colour: 5YR 5/4 (reddish brown); sand inclusions;

medium-low firing temperature.
Description: triangular rim bowl.

AbT.14.240.8 - Fig. 7.84

Dimensions: wall th.: 0.7 cm.
Clay: outer, inner and fabric colour: 10YR 6/2 (light brownish grey); sand inclusions; medium-high firing temperature.
Description: wall fragment with small circular impressions.

Catalogue of US 244 Finds

*Pottery***AbT.14.244.1 - Fig. 7.84**

Dimensions: rim diam.: 28 cm; rim th.: 1.5 cm; wall th.: 0.9 cm.
Clay: outer and inner colour: 2.5Y 8/3 (pale brown); fabric colour: 2.5YR 5/4 (reddish brown); sand inclusions; medium-low firing temperature.
Description: triangular rim bowl.

AbT.14.244.2 - Fig. 7.84

Dimensions: wall th.: 1 cm; base diam.: 5 cm; base th.: 1 cm.
Clay: outer, inner and fabric colour: 5YR 5/6 (yellowish red); sand inclusions; medium-high firing temperature.
Description: beaker base.

AbT.14.244.3 - Fig. 7.84

Dimensions: rim diam.: 17 cm; rim th.: 0.6 cm; wall th.: 0.6 cm; base diam.: 3.5 cm; base th.: 0.8 cm; h.: 8 cm.
Clay: outer colour: 7.5YR 8/2 (pinkish white); inner colour: 5YR 6/4 (light reddish brown); fabric colour: 5YR 5/4 (reddish brown); sand inclusions; medium-high firing temperature.
Description: conical bowl.

AbT.14.244.4 - Fig. 7.84

Dimensions: rim diam.: 31 cm; rim th.: 1.5 cm; wall th.: 1 cm.
Clay: outer, inner and fabric colour: 5YR 5/6 (yellowish red); sand inclusions; medium firing temperature.
Description: triangular rim bowl.

AbT.14.244.5 - Fig. 7.84

Dimensions: rim diam.: 16 cm; rim th.: 0.9 cm; wall th.: 0.9 cm.
Clay: outer and inner colour: 10YR 8/3 (very pale brown); fabric colour: 5YR 4/4 (reddish brown); sand inclusions;

medium firing temperature.
Description: plain rim jar.

AbT.14.244.6 - Fig. 7.84

Dimensions: rim diam.: 12 cm; rim th.: 0.6 cm; wall th.: 0.7 cm.
Clay: outer and inner colour: 7.5YR 8/3 (pink); fabric colour: 5YR 5/4 (reddish brown); sand inclusions; medium-low firing temperature.
Description: plain rim jar (incised line between the neck and the shoulder).

AbT.14.244.7 - Fig. 7.84

Dimensions: rim diam.: 12 cm; rim th.: 0.6 cm; wall th.: 1 cm.
Clay: outer, inner and fabric colour: 5Y 8/2 (pale yellow); sand inclusions; high firing temperature.
Description: band rim jar.

AbT.14.244.8 - Fig. 7.84

Dimensions: wall th.: 1.4 cm; base diam.: 16 cm; base th.: 1 cm.
Clay: outer and inner colour: 7.5YR 6/4 (light brown); fabric colour: 7.5YR 5/4 (brown); sand inclusions; medium-high firing temperature.
Description: stemmed-dish base.

Catalogue of US 290 Finds

*Pottery***AbT.14.290.1 - Fig. 7.85**

Dimensions: wall th.: 0.7 cm; base diam.: 3.5 cm; base th.: 1 cm.
Clay: outer, inner and fabric colour: 5YR 6/4 (light reddish brown); sand inclusions; medium-low firing temperature.
Description: beaker base.

AbT.14.290.2 (+296.4) - Fig. 7.85

Dimensions: rim diam.: 20 cm; rim th.: 0.9 cm; wall th.: 0.9 cm.
Clay: outer, inner and fabric colour: 5YR 6/6 (reddish yellow); sand inclusions; medium-low firing temperature.
Description: stemmed-dish bowl. Oblique notches of 0.4 cm on the two ridges of the rim. A second piece was found in one of the lower strata, inside Building A Room 10.
Note: in § 10 the fragment was considered together with the decorated pieces coming from Building A.

Catalogue of US 294 Finds

*Objects***AbT.14.98 - Fig. 7.83**

Description: reddish stone tool. Burnt?
Dimensions: 9.7x6.1x10 cm.

*Pottery***AbT.14.294.1 - Fig. 7.85**

Dimensions: rim diam.: 16 cm; rim th.: 1.9 cm; wall th.: 0.7 cm.
Clay: outer, inner and fabric colour: 5YR 7/8 (reddish yellow); sand inclusions; medium-low firing temperature.
Description: triangular rim bowl

(poorly shaped version). Incision under the rim (one parallel to the rim and other oblique lines).

AbT.14.294.2 - Fig. 7.85

Dimensions: wall th.: 0.9 cm.
Clay: outer and inner colour: 2.5Y 8/2 (pale brown); fabric colour: 5YR 6/6 (reddish yellow); sand inclusions; medium-high firing temperature.
Description: wall fragment of a stem decorated with hatched incisions and excissions.

Catalogue of US 329 Finds

*Pottery***AbT.15.329.1 - Fig. 7.85**

Dimensions: rim diam.: 15 cm; rim th.: 0.7 cm; wall th.: 1.2 cm; base diam.: 4.7 cm; base th.: 1.3 cm; h.: 6.5 cm.
Clay: outer and inner colour: 10YR 8/2 (verypale brown); sand inclusions; medium-low firing temperature.
Description: conical bowl.

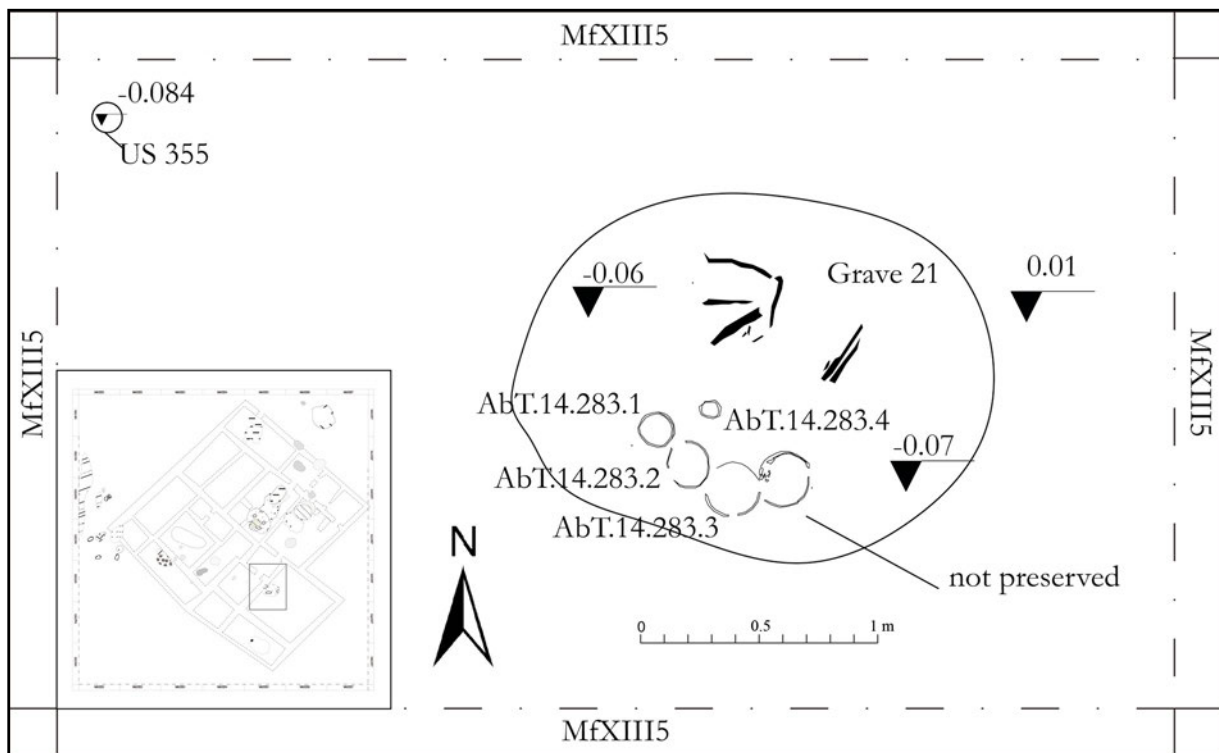

Fig. 7.86 Grave 21 plan.

7.6 MfXIII3-5 [LR]

7.6.1 OTHER ACTIVITIES [LR]

In this area a posthole (US 354; cut US 355) and a pit with two conical bowls on the bottom were found (see § 8.15).

7.6.2 GRAVE 21 [LR]

In MfXIII5 Grave 21 (Figs 7.86-87) was discovered immediately under the surface, mostly eroded. Thus, the cut (US 285)⁴¹ was not clearly evident and the skeleton (US 284) badly damaged by salinization.

The silty soil that filled the grave (US 283) was light olive brown in colour. Four jars were deposited along the southern limit of the grave, each with only the base preserved; a conical bowl was between the jars and the body, probably near the original position of the hands. Unfortunately, the vessels were destroyed, probably by Bedouins, on the 23rd of October 2014 after we left the site:



Fig. 7.87 Grave 21 before the damages.

only three bases of jars were recovered in the spot together with a conical bowl base, all recorded in the catalogue. The body laid apparently in semiflexed position with the head plausibly located north-west and the feet toward south-east, the legs bent toward south. Also, the arms were apparently bent.

⁴¹ The cut was bigger in the upper part and tapering down, reaching a maximum dept of -0.07 m. One of the walls of Building A was cut by the grave.

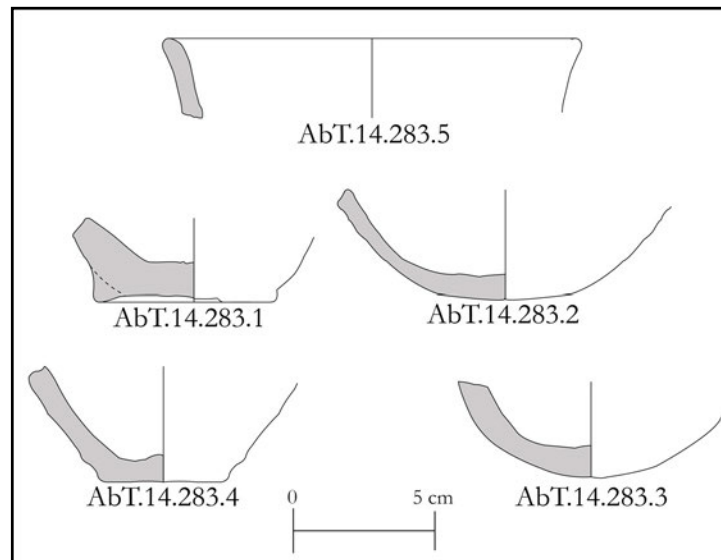

Fig. 7.88 US 283 pottery.

Catalogue of US 283 Finds

Pottery

AbT.14.283.1 - Fig. 7.88

Dimensions: base diam.: 8.5 cm; base th.: 1 cm.

Clay: outer and inner colour (self-slip): 2.5Y 8/2 (pale brown); fabric colour: 5YR 5/4 (reddish brown); sand inclusions; medium-low firing temperature.

Description: jar base with three feet.

AbT.14.283.2 - Fig. 7.88

Dimensions: wall th.: 0.7 cm; base diam.: 7 cm; base th.: 0.7 cm.

Clay: outer, inner and fabric colour: 5YR 5/4 (reddish brown); sand inclusions; medium-low firing temperature.

Description: slightly convex base.

AbT.14.283.3 - Fig. 7.88

Dimensions: wall th.: 1 cm; base diam.: 4.5 cm.

Clay: outer colour (self-slip): 2.5Y 8/2 (pale brown); inner and fabric colour: 5YR 5/4 (reddish brown); sand inclusions; medium firing temperature.

Description: convex base.

AbT.14.283.4 - Fig. 7.88

Dimensions: wall th.: 0.9 cm; base diam.: 5 cm; base th.: 0.9 cm.

Clay: outer colour: 5YR 5/6 (yellowish red); inner and fabric colour: 7.5YR 4/4 (brown); sand inclusions; medium-

low firing temperature.

Description: conical bowl base.

AbT.14.283.5 - Fig. 7.87

Dimensions: rim diam.: 14 cm; rim th.: 0.7 cm; wall th.: 0.7 cm.

Clay: outer, inner and fabric colour: 2.5Y 8/3 (pale brown); sand inclusions; medium-high firing temperature.

Description: plain rim jar.

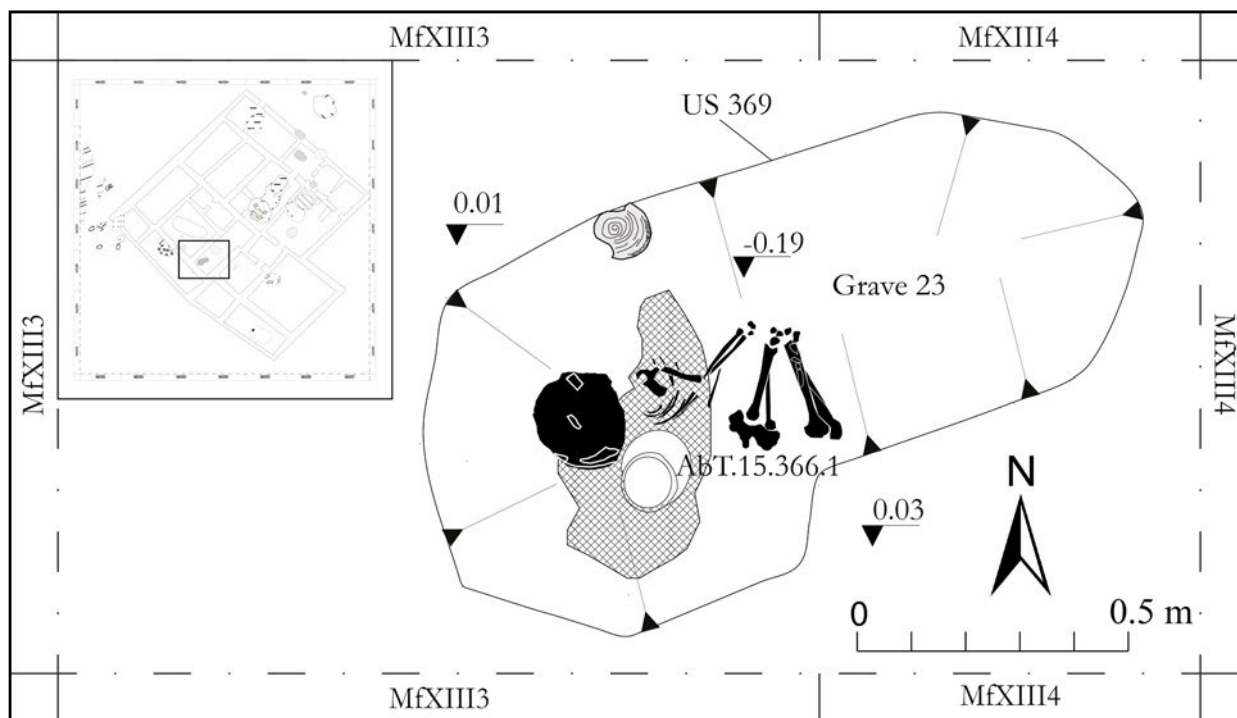

Fig. 7.89 Grave 23 plan.



Fig. 7.90 Grave 23 and detail of the reed basket.

Fig. 7.91 (right) US 366 pottery.

7.6.3 GRAVE 23 [LR]

Grave 23 (Figs 7.89-90) was located in square MfXIII3-4. It was a simple inhumation of a child (US 367), wrapped in a reed-mat (US 368). The soil was soft and brown in colour (US 366; cut US 369) and covered the body and the simple equipment, consisting of a jar and a small circular reed basket (Fig. 7.90). The maximum dept reached by the grave is -0.19 m. The body was placed in foetal position on his left side, with the head toward west and looking north, the legs bent.

Catalogue of US 366 Finds

Pottery

AbT.15.366.1 - Fig. 7.91

Dimensions: rim diam.: 9 cm; rim th.: 0.7 cm; wall th.: 0.7 cm; base diam.: 6 cm; base th.: 0.9 cm; h.: 15 cm.

Clay: outer and inner colour: 7.5YR 7/4 (pink); fabric colour: 2.5YR 5/4 (reddish brown); sand inclusions; medium-low firing temperature.

Description: small double-ridged rim jar.

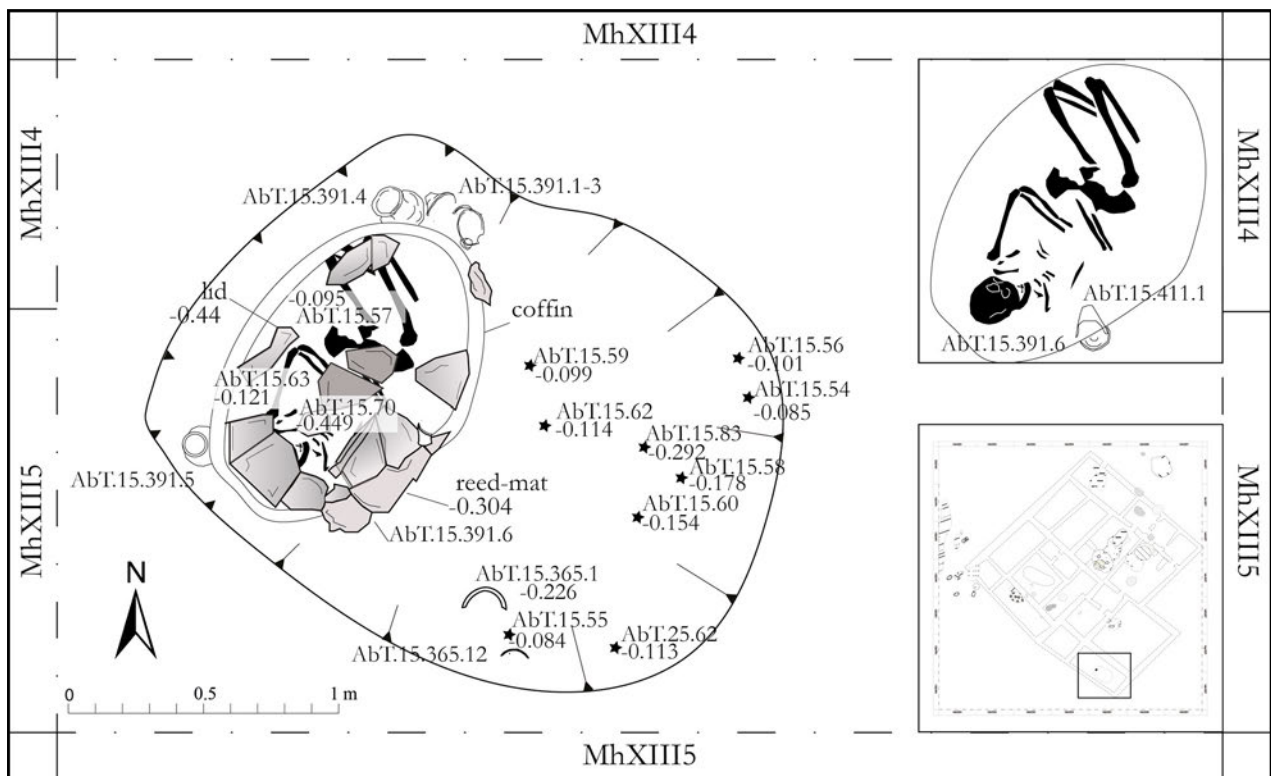

Fig. 7.92 Grave 24 plan.

7.7 MG-HXIII5-4 [LR]

7.7.1 GRAVE 24 [LR]

A big cut (US 373) was realized at 0.1 m of elevation in Mg-hXIII5-4 in order to host the sarcophagus (US 371) of Grave 24 (Figs 7.92-94). The cut was deeper toward north-west, reaching a maximum depth of -0.6 m ca. The backfill of the cut (US 365), was a very friable dark yellowish brown silty-clay soil, containing bitumen objects, lots of pottery shards and many stone tools and chert blades.⁴² The lid of the coffin (US 375), found at -0.44 m of elevation, was in fragments.⁴³ The soil immediately over the lid's fragments (US 372) contained a sort of shell handle (?) covered by a copper alloy lamina: it is not clear if the object was originally part of the equipment of the grave.⁴⁴

⁴² The grave cut Room 23, in which a bitumen workshop plenty of lithic tools was discovered (see § 9): it is thus probable that the huge number of stone tools in the filling were due to the reuse of the soil, first removed and then used to fill the cut. Apart from the pottery in the catalogue, other 15 bases of drinking vessels were found.

⁴³ Due probably to the weight of the soil.

⁴⁴ In this case we should hypothesize a looting activity that however did not leave traces: the skeleton, though in bad condition, was still in its primary position, with the bones in connection.

Under the lid reed-mat traces covered both the inner and the outer side of the coffin. It might be that the reed-mat was used to lift the lid and laid it over the coffin.

The skeleton (US 374), laying in a semi-flexed position, was poorly preserved: the bones were crushed (vertebrae, hips, all the left arm) by the collapsed lid and the skull showed a hole in the centre. The body was deposited with the head toward south-west looking west, the legs were bent toward north leaning against the western wall of the sarcophagus. The arms were flexed with the hands on the hips. Traces of reed-mat were also found above the skeleton. The coiled sarcophagus was realized in coarse pottery, with a ring base, three ridges on the external wall and an out-turned triangular rim. Around it, the pottery equipment (US 391 - Fig. 7.95) was placed: two jars and a conical bowl were deposited near the north-east edge of the coffin; another jar on the south-west side and a conical bowl along the south side. After the removal of the coffin, a beaker was discovered under it (US 411).



Fig. 7.93 Grave 24 with the lid (US 375) still *in situ*.

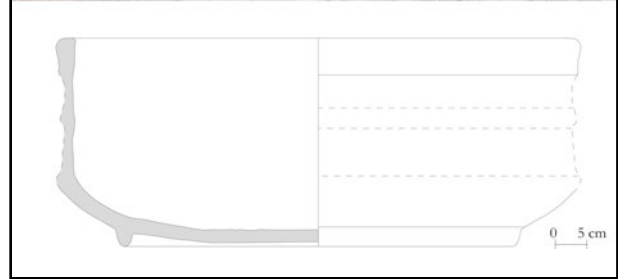
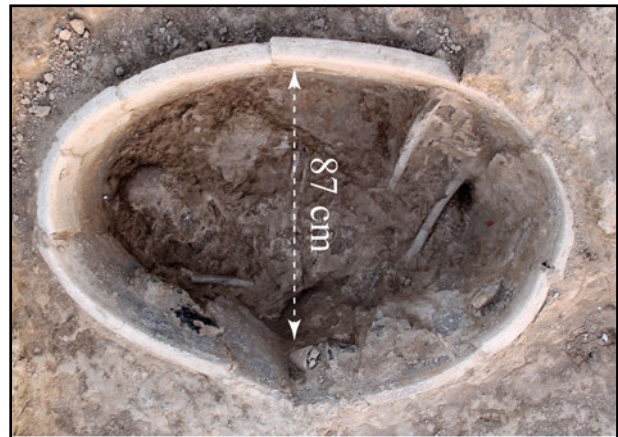

Fig. 7.94 Grave 24 skeleton (US 374) and coffin (US 371).



Fig. 7.95 Grave 24 pottery equipment (US 391).

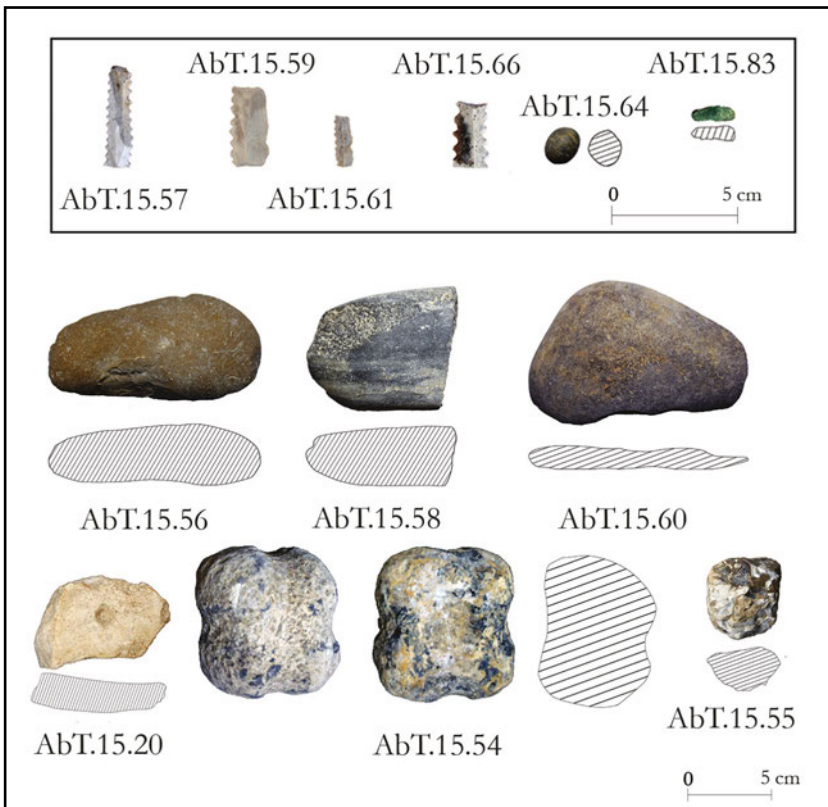

Fig. 7.96 US 365 objects.

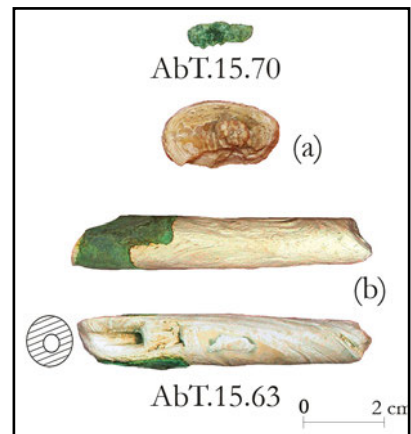

Fig. 7.97 US 372 objects.

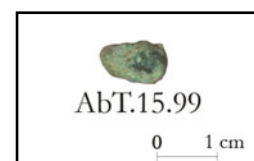

Fig. 7.98 US 391 objects.

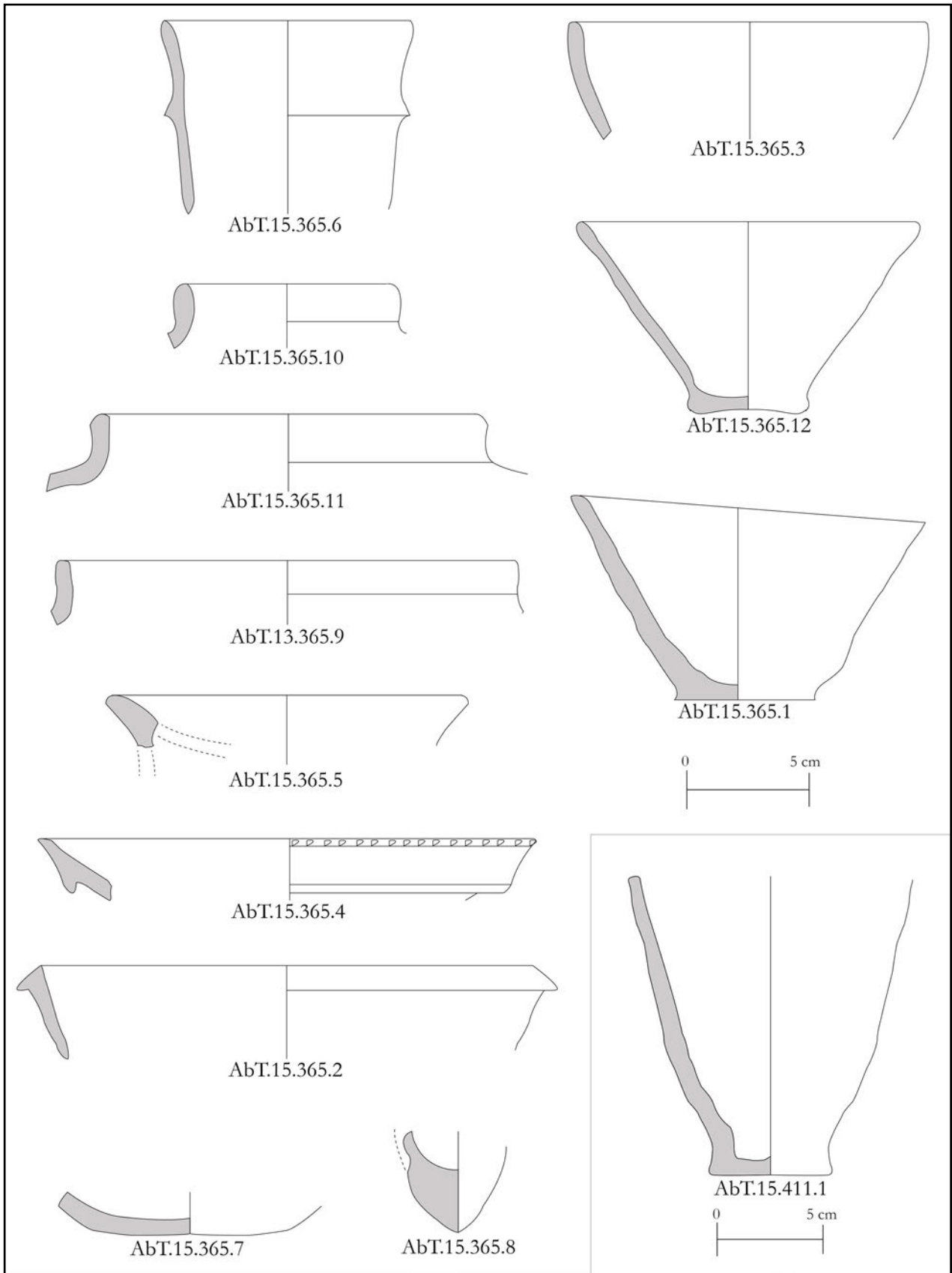

Fig. 7.99 US 365 and US 411 pottery.

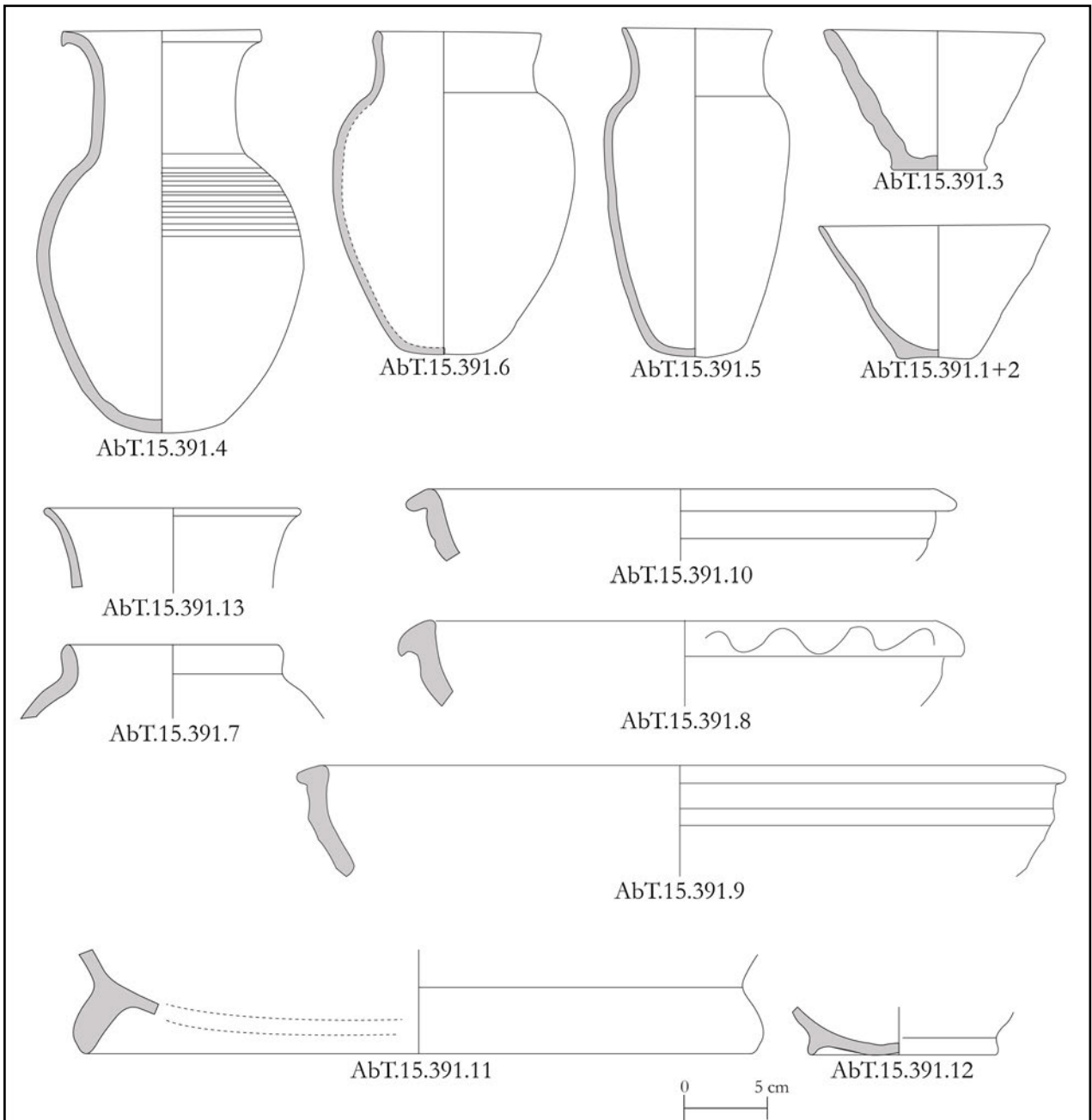

Fig. 7.100 US 391 pottery.

Catalogue of US 365 Finds

*Objects***AbT.15.20 - Fig. 7.96**

Description: reused limestone vessel (drilled). [SC]

Dimensions: 5.1x7.9x8.2x2 cm.

AbT.15.54 - Fig. 7.96

Description: limestone mace-head. The grooves were made in order to fit the ropes that held the macehead to a haft. The grooves were created by pecking the surface, however traces of the actual ropes or hide used to haft the macehead are not recognizable autoptically. Bitumen traces are visible on all the surface but in small quantities. The base of the artifact presents different chromatic shades, maybe due to the action of fire. A shallow depression is visible on the base of the object which was probably used to set the haft (whatever the haft's raw material was). This last trace was created by pecking. The base of the object is flattened. [SC]

Dimensions: 6.9x5.4x8.1 cm; weight 694 gr.

AbT.15.55 - Fig. 7.96

Description: chert weight(?). Heavy patina. As others it has two flatter faces (due to contact?) The other faces show no traces of flaking. [SC]

Dimensions: 4.9x4.5x3.9 cm; weight 104 gr.

AbT.15.56 - Fig. 7.96

Description: fractured big dimension multifunctional stonetool. The fracture could be intentional. The outer surface of the stone has a few flake negatives and several striations, but it is hard to be sure if the traces are intentional or not. The right hand cutting edge shows small traces of use. The fractured half shows traces of abrasion (striations) and surface levelling. [SC]

Dimensions: 5.9x12x2.9 cm; weight 268 gr.

AbT.15.57 - Fig. 7.96

Description: chert sickle element.

Dimensions: 1.1x4.1x0.4 cm.

AbT.15.58 - Fig. 7.96

Description: fragment of a stone pestle-multifunctional tool. Functional

areas show a general levelling due to use, abrasion and possibly polishing with more or less localized and precise use, light pounding traces. [SC]

Dimensions: 7x9x3.8 cm; weight 391 gr.

AbT.15.59 - Fig. 7.96

Description: sickle element.

Dimensions: 1.6x3.3x0.4 cm.

AbT.15.60 - Fig. 7.96

Description: fragment of a multifunctional stone tool. Functional areas show many perpendicular striations, pounding traces, big and small negative flakes possibly due to use, and some light rounding. [SC]

Dimensions: 8x12x2.5 cm; weight 353 gr.

AbT.15.61 - Fig. 7.96

Description: chert sickle element.

Dimensions: 1.2x2.1x0.2 cm.

AbT.15.64 - Fig. 7.96

Description: small river pebble. [SC]

Dimensions: 1.2x1.6x1.2 cm; weight 3 gr.

AbT.15.66 - Fig. 7.96

Description: chert sickle element.

Dimensions: 1.2x2.2x0.2 cm.

AbT.15.83 - Fig. 7.96

Description: copper alloy fragment.

Dimensions: 2 cm ca.

*Pottery***AbT.15.365.1 - Fig. 7.99**

Dimensions: rim diam.: 14 cm; rim th.: 0.6 cm; wall th.: 0.7 cm; base diam.: 6 cm; base th.: 0.8 cm; h.: 8 cm.

Clay: outer and inner colour: 10YR 7/4 (very pale brown); sand inclusions; medium firing temperature.

Description: conical bowl.

AbT.15.365.2 - Fig. 7.99

Dimensions: rim diam.: 20 cm; rim th.: 1.1 cm; wall th.: 0.6 cm.

Clay: outer and inner colour: 2.5YR 6/6 (light red); fabric colour: 2.5YR 4/4 (reddish brown); sand inclusions; medium-low firing temperature.

Description: triangular rim bowl.

AbT.15.365.3 - Fig. 7.99

Dimensions: rim diam.: 14 cm; rim th.:

0.6 cm; wall th.: 0.4 cm.

Clay: outer, inner and fabric colour: 2.5YR 7/3 (light reddish brown); sand inclusions; medium-low firing temperature.

Description: conical bowl rim.

AbT.15.365.4 - Fig. 7.99

Dimensions: rim diam.: 20 cm ca.; rim th.: 1 cm; wall th.: 0.7 cm.

Clay: outer, inner and fabric colour: 2.5YR 7/3 (light reddish brown); sand inclusions; medium-low firing temperature.

Description: band rim of a stemmed-dish bowl with notches on the upper part.

AbT.15.365.5 - Fig. 7.99

Dimensions: rim diam.: 14 cm; rim th.: 1 cm; wall th.: 1 cm.

Clay: outer, inner and fabric colour: 5YR 6/4 (light reddish brown); sand inclusions; medium-low firing temperature.

Description: conical bowl attached to a stand.

AbT.15.365.6 - Fig. 7.99

Dimensions: rim diam.: 10 cm; rim th.: 0.4 cm; wall th.: 0.5 cm.

Clay: outer and inner colour: 2.5YR 6/4 (light reddish brown); fabric colour: 2.5YR 4/4 (reddish brown); sand inclusions; medium-high firing temperature.

Description: band rim jar.

AbT.15.365.7 - Fig. 7.99

Dimensions: rim diam.: 8 cm; rim th.: 0.7 cm; wall th.: 0.8 cm.

Clay: outer colour: 10YR 7/3 (very pale brown); inner and fabric colour: 7.5YR 5/4 (brown); sand inclusions; medium-high firing temperature.

Description: flat base of a jar.

AbT.15.365.8 - Fig. 7.99

Dimensions: base diam.: 3 cm; base th.: 2.5 cm.

Clay: outer and inner colour: 5YR 6/6 (reddish yellow); fabric colour: 5YR 7/4 (pink); sand inclusions; medium-low firing temperature.

Description: pointed base.

AbT.15.365.9 - Fig. 7.99

Dimensions: rim diam.: 18 cm; rim th.: 0.6 cm; wall th.: 0.8 cm.

Clay: outer, inner and fabric colour:

2.5Y 7/4 (pale brown); sand inclusions; medium firing temperature.
Description: plain rim jar.

AbT.15.365.10 - Fig. 7.99

Dimensions: rim diam.: 8 cm; rim th.: 0.7 cm; wall th.: 0.8 cm.

Clay: outer colour: 10YR 6/4 (light yellowish brown); inner colour: 10YR 7/4 (very pale brown); fabric colour: 5YR 6/4 (light reddish brown); sand inclusions; medium-high firing temperature.

Description: plain rim jar.

AbT.15.365.11 - Fig. 7.99

Dimensions: rim diam.: 15 cm; rim th.: 0.9 cm; wall th.: 0.7 cm.

Clay: outer colour: 2.5YR 7/2 (pale red); inner colour: 10YR 7/3 (very pale brown); fabric colour: 5YR 6/4 (light reddish brown); sand inclusions; medium-low firing temperature.

Description: plain rim jar.

AbT.15.365.12 - Fig. 7.99

Dimensions: rim diam.: 14.3 cm; rim th.: 0.7 cm; wall th.: 0.7 cm; base diam.: 4.5 cm; base th.: 0.8 cm; h.: 7.5 cm.

Clay: outer, inner and fabric colour: 5YR 7/3 (pink); sand inclusions; medium-low firing temperature.

Description: conical bowl.

Catalogue of US 371 Finds

Pottery

AbT.15.371.1 - Fig. 7.94

Dimensions: rim diam.: 87 cm; rim th.: 3 cm; wall th.: 1.3 cm; base diam.: 65 cm; base th.: 2.4 cm; h.: 34 cm.

Clay: outer, inner and fabric colour: 10YR 7/3 (very pale brown); sand and vegetal inclusions; medium firing temperature.

Description: coiled coffin with two ridges on the wall and ring base.

Catalogue of US 372 Finds

Objects

AbT.15.63 a-b - Fig. 7.97

Description: shell objects: (a) operculum and (b) columella covered with a copper-alloy lamina. Handle?

Dimensions: (a) 1.6x2.8x1.1cm; (b) 1.3x6.7x1.2 cm.

AbT.15.70 - Fig. 7.97

Description: copper alloy fragment.

Dimensions: 0.6x1.6x0.2 cm.

Catalogue of US 391 Finds

Objects

AbT.15.99 - Fig. 7.98

Description: copper alloy fragment.

Dimensions: 0.7x1.1x0.5 cm.

Pottery

AbT.15.391.1+2 - Fig. 7.100

Dimensions: rim diam.: 14.5 cm; rim th.: 0.8 cm; wall th.: 0.8 cm; base diam.: 4.5 cm; base th.: 0.8 cm; h.: 8 cm.

Clay: outer colour: 2.5YR 5/6 (red); inner and fabric colour: 5YR 5/6 (yellowish red); sand inclusions; low firing temperature.

Description: conical bowl.

AbT.15.391.3 - Fig. 7.100

Dimensions: rim diam.: 14 cm; rim th.: 0.6 cm; wall th.: 0.9 cm; base diam.: 5.6 cm; base th.: 0.8 cm; h.: 8.2 cm.

Clay: outer, inner and fabric colour: 5YR 7/6 (reddish yellow); sand inclusions; medium-low firing temperature.

Description: conical bowl.

AbT.15.391.4 - Fig. 7.100

Dimensions: rim diam.: 12 cm; rim th.: 0.7 cm; wall th.: 1 cm; base diam.: 7.9 cm; base th.: 0.8 cm; h.: 24.6 cm.

Clay: outer and inner colour: 10YR 7/3 (very pale brown); sand inclusions; medium firing temperature.

Description: triangular rim jar with combed-like decoration/grooves on the shoulders.

AbT.15.391.5 - Fig. 7.100

Dimensions: rim diam.: 9 cm; rim th.: 0.3 cm; wall th.: 0.5 cm; base diam.: 5.4 cm; base th.: 0.5 cm; h.: 19.5 cm.

Clay: outer and inner colour: 7.5YR 8/2 (pinkish white); sand inclusions; medium firing temperature.

Description: plain rim jar.

AbT.15.391.6 - Fig. 7.100

Dimensions: rim diam.: 10 cm; rim th.: 0.4 cm; wall th.: 0.5 cm; base diam.: 5.5

cm; h.: 20 cm.

Clay: outer and inner colour: 7.5YR 8/2 (pinkish white); sand inclusions; medium-low firing temperature.

Description: plain rim jar.

AbT.15.391.7 - Fig. 7.100

Dimensions: rim diam.: 12.6 cm; rim th.: 0.7 cm; wall th.: 0.8 cm.

Clay: outer, inner and fabric colour: 2.5Y 6/4 (light yellowish brown); sand inclusions; medium firing temperature.

Description: plain rim jar.

AbT.15.391.8 - Fig. 7.100

Dimensions: rim diam.: 30 cm; rim th.: 2.3 cm; wall th.: 1.3 cm.

Clay: outer, inner and fabric colour: 2.5Y 8/2 (pale brown); sand inclusions; medium-high firing temperature.

Description: triangular rim bowl with weavy incisions.

AbT.15.391.9 - Fig. 7.100

Dimensions: rim diam.: 40 cm; rim th.: 2.3 cm; wall th.: 1 cm.

Clay: outer colour: 2.5YR 6/4 (light reddish brown); inner and fabric colour: 7.5YR 6/4 (light brown); sand inclusions; medium-low firing temperature.

Description: triangular rim bowl.

AbT.15.391.10 - Fig. 7.100

Dimensions: rim diam.: 30 cm; rim th.: 1.5 cm; wall th.: 0.9 cm.

Clay: outer, inner and fabric colour: 10YR 7/3 (very pale brown); sand inclusions; medium firing temperature.

Description: triangular rim bowl with a groove on the wall.

AbT.15.391.11 - Fig. 7.100

Dimensions: base diam.: 40 cm; base th.: 1 cm.

Clay: outer, inner and fabric colour: 10YR 8/2 (very pale brown); sand and vegetal inclusions; medium firing temperature.

Description: ring base.

AbT.15.391.12 - Fig. 7.100

Dimensions: rim diam.: 11 cm; rim th.: 0.6 cm; wall th.: 0.5 cm.

Clay: outer, inner and fabric colour: 2.5Y 8/2 (pale brown); sand inclusions; medium-high firing temperature.

Description: ring base.

AbT.15.391.13 - Fig. 7.100

Dimensions: rim diam.: 15 cm; rim th.: 0.8 cm; wall th.: 0.6 cm.

Clay: outer and inner colour: 10YR 7/3 (very pale brown); fabric colour: 5YR 7/4 (pink); sand inclusions; medium-low firing temperature.

Description: plain rim jar.

Catalogue of US 411 Finds

*Pottery***AbT.15.411.1 - Fig. 7.99**

Dimensions: wall th.: 1 cm; base diam.: 5.5 cm; base th.: 1.2 cm; h.: 14.2 cm.

Clay: outer, inner and fabric colour: 5Y 6/3 (pale olive); sand inclusions; medium-high firing temperature.

Description: beaker base.