

## Quality control and beam test of GEM detectors for future upgrades of the CMS muon high rate region at the LHC

This content has been downloaded from IOPscience. Please scroll down to see the full text.

2015 JINST 10 C03039

(<http://iopscience.iop.org/1748-0221/10/03/C03039>)

View [the table of contents for this issue](#), or go to the [journal homepage](#) for more

Download details:

IP Address: 128.141.252.85

This content was downloaded on 09/02/2016 at 16:11

Please note that [terms and conditions apply](#).

10<sup>th</sup> INTERNATIONAL CONFERENCE ON POSITION SENSITIVE DETECTORS  
7–12 SEPTEMBER 2014,  
UNIVERSITY OF SURREY, GUILDFORD, SURREY, U.K.

## Quality control and beam test of GEM detectors for future upgrades of the CMS muon high rate region at the LHC

D. Abbaneo,<sup>o</sup> M. Abbas,<sup>o</sup> M. Abbrescia,<sup>b</sup> A.A. Abdelalim,<sup>g</sup> M. Abi Akl,<sup>m</sup> W. Ahmed,<sup>g</sup> W. Ahmed,<sup>q</sup> P. Altieri,<sup>b</sup> R. Aly,<sup>g</sup> C. Armaingaud,<sup>a</sup> C. Asawatangtrakuldee,<sup>c</sup> A. Ashfaq,<sup>q</sup> P. Aspell,<sup>o</sup> Y. Assran,<sup>h</sup> I. Awan,<sup>q</sup> S. Bally,<sup>o</sup> Y. Ban,<sup>c</sup> S. Banerjee,<sup>s</sup> P. Barria,<sup>e</sup> L. Benussi,<sup>n</sup> V. Bhopatkar,<sup>v</sup> S. Bianco,<sup>n</sup> J. Bos,<sup>o</sup> O. Bouhali,<sup>m</sup> S. Braibant,<sup>d</sup> S. Buontempo,<sup>x</sup> J. Cai,<sup>e</sup> C. Calabria,<sup>b</sup> M. Caponero,<sup>n</sup> C. Caputo,<sup>b</sup> F. Cassese,<sup>x</sup> A. Castaneda,<sup>m</sup> S. Cauwenbergh,<sup>p</sup> F.R. Cavallo,<sup>d</sup> A. Celik,<sup>i</sup> M. Choi,<sup>ae</sup> K. Choi,<sup>ae</sup> S. Choi,<sup>ac</sup> J. Christiansen,<sup>o</sup> A. Cimmino,<sup>p</sup> S. Colafranceschi,<sup>o</sup> A. Colaleo,<sup>b</sup> A. Conde Garcia,<sup>o</sup> M.M. Dabrowski,<sup>o</sup> G. De Lentdecker,<sup>e</sup> R. De Oliveira,<sup>o</sup> G. De Robertis,<sup>b</sup> S. Dildick,<sup>i</sup> S. Dildick,<sup>p</sup> B. Dorney,<sup>o</sup> W. Elmetenawee,<sup>g</sup> G. Fabrice,<sup>aa</sup> M. Ferrini,<sup>n</sup> S. Ferry,<sup>o</sup> W. Flanagan,<sup>j</sup> P. Giacomelli,<sup>d</sup> J. Gilmore,<sup>j</sup> L. Guiducci,<sup>d</sup> A. Gutierrez,<sup>l</sup> R.M. Hadjiiska,<sup>ab</sup> A. Hassan,<sup>g</sup> J. Hauser,<sup>u</sup> K. Hoepfner,<sup>a</sup> M. Hohlmann,<sup>v</sup> H. Hoorani,<sup>q</sup> Y.G. Jeng,<sup>r</sup> T. Kamon,<sup>i</sup> P.E. Karchin,<sup>l</sup> H.S. Kim,<sup>r</sup> V. Khotilovich,<sup>j</sup> S. Krutelyov,<sup>i</sup> A. Kumar,<sup>k</sup> J. Lee,<sup>ae</sup> T. Lenzi,<sup>e</sup> L. Litov,<sup>ab</sup> F. Loddo,<sup>b</sup> T. Maerschalk,<sup>e</sup> G. Magazzu,<sup>z</sup> M. Maggi,<sup>b</sup> Y. Maghrbi,<sup>m</sup> A. Magnani,<sup>y</sup> N. Majumdar,<sup>s</sup> P.K. Mal,<sup>f</sup> K. Mandal,<sup>f</sup> A. Marchioro,<sup>o</sup> A. Marinov,<sup>o</sup> J.A. Merlin,<sup>o</sup> N. Mohammed,<sup>k</sup> A.K. Mohanty,<sup>w</sup> A. Mohapatra,<sup>v</sup> S. Muhammad,<sup>q</sup> S. Mukhopadhyay,<sup>s</sup> M. Naimuddin,<sup>k</sup> S. Nuzzo,<sup>b</sup> E. Oliveri,<sup>o</sup> L.M. Pant,<sup>w</sup> P. Paolucci,<sup>x</sup> I. Park,<sup>ae</sup> G. Passeggio,<sup>x</sup> B. Pavlov,<sup>ab</sup> B. Philipps,<sup>a</sup> M. Phipps,<sup>v</sup> D. Piccolo,<sup>n</sup> H. Postema,<sup>o</sup> G. Pugliese,<sup>b</sup> A. Puig Baranac,<sup>o</sup> A. Radi,<sup>h</sup> R. Radogna,<sup>b</sup> G. Raffone,<sup>n</sup> S. Ramkrishna,<sup>k</sup> A. Ranieri,<sup>b</sup> C. Riccardi,<sup>y</sup> A. Rodrigues,<sup>o</sup> L. Ropelewski,<sup>o</sup> S. RoyChowdhury,<sup>s</sup> M.S. Ryu,<sup>r</sup> G. Ryu,<sup>ae</sup> A. Safonov,<sup>i</sup> A. Sakharov,<sup>j</sup> S. Salva,<sup>p,1</sup> G. Saviano,<sup>n</sup> A. Sharma,<sup>o</sup> S.K. Swain,<sup>f</sup> J.P. Talvitie,<sup>o</sup> J.P. Talvitie,<sup>t</sup> C. Tamma,<sup>b</sup> A. Tatarinov,<sup>i</sup> H. Teng,<sup>e</sup> N. Turini,<sup>z</sup> T. Tuuva,<sup>t</sup> J. Twigger,<sup>v</sup> M. Tytgat,<sup>p</sup> I. Vai,<sup>y</sup> M. Van Stenis,<sup>o</sup> R. Venditi,<sup>b</sup> E. Verhagen,<sup>e</sup> P. Verwilligen,<sup>b</sup> P. Vitulo,<sup>y</sup> D. Wang,<sup>c</sup> M. Wang,<sup>c</sup> U. Yang,<sup>ad</sup> Y. Yang,<sup>e</sup> R. Yonamine,<sup>e</sup> N. Zaganidis,<sup>p</sup> F. Zenoni<sup>e</sup> and A. Zhang<sup>v</sup>

<sup>1</sup>Corresponding author.

<sup>a</sup>*RWTH Aachen University, III Physikalisches Institut A, Aachen, Germany*

<sup>b</sup>*Politecnico di Bari, Universite di Bari and INFN Sezione di Bari, Bari, Italy*

<sup>c</sup>*Peking University, Beijing, China*

<sup>d</sup>*University and INFN Bologna, Bologna, Italy*

<sup>e</sup>*Universite Libre de Bruxelles, Brussels, Belgium*

<sup>f</sup>*National Institute of Science Education and Research, Bhubaneswar*

<sup>g</sup>*Helwan University & CTP, Cairo, Egypt*

<sup>h</sup>*Academy of Scientific Research and Technology, ENHEP, Cairo, Egypt*

<sup>i</sup>*Texas A&M University, College Station, U.S.A.*

<sup>j</sup>*Kyungpook National University, Daegu, Korea*

<sup>k</sup>*University of Delhi, Delhi, India*

<sup>l</sup>*Wayne State University, Detroit, U.S.A.*

<sup>m</sup>*Texas A&M University at Qatar, Doha, Qatar*

<sup>n</sup>*Laboratori Nazionali di Frascati - INFN, Frascati, Italy*

<sup>o</sup>*CERN, Geneva, Switzerland*

<sup>p</sup>*Ghent University, Dept. of Physics and Astronomy, Ghent, Belgium*

<sup>q</sup>*National Center for Physics, Quaid-i-Azam University Campus, Islamabad, Pakistan*

<sup>r</sup>*National University, Jeonju, Korea*

<sup>s</sup>*Saha Institute of Nuclear Physics, Kolkata, India*

<sup>t</sup>*Lappeenranta University of Technology, Lappeenranta, Finland*

<sup>u</sup>*University of California, Los Angeles, U.S.A.*

<sup>v</sup>*Florida Institute of Technology, Melbourne, U.S.A.*

<sup>w</sup>*Bhabha Atomic Research Centre, Mumbai, India*

<sup>x</sup>*INFN Napoli, Napoli, Italy*

<sup>y</sup>*INFN Pavia and University of Pavia, Pavia, Italy*

<sup>z</sup>*INFN Sezione di Pisa, Pisa, Italy*

<sup>aa</sup>*IRFU CEA-Saclay, Saclay, France*

<sup>ab</sup>*Sofia University, Sofia, Bulgaria*

<sup>ac</sup>*Korea University, Seoul, Korea*

<sup>ad</sup>*Seoul National University, Seoul, Korea*

<sup>ae</sup>*University of Seoul, Seoul, Korea*

*E-mail: [Sinem.Salva@ugent.be](mailto:Sinem.Salva@ugent.be)*

**ABSTRACT:** Gas Electron Multipliers (GEM) are a proven position sensitive gas detector technology which nowadays is becoming more widely used in High Energy Physics. GEMs offer an excellent spatial resolution and a high particle rate capability, with a close to 100% detection efficiency. In view of the high luminosity phase of the CERN Large Hadron Collider, these aforementioned features make GEMs suitable candidates for the future upgrades of the Compact Muon Solenoid (CMS) detector. In particular, the CMS GEM Collaboration proposes to cover the high-eta region of the muon system with large-area triple-GEM detectors, which have the ability to provide robust and redundant tracking and triggering functions. In this contribution, after a general introduction

and overview of the project, the construction of full-size trapezoidal triple-GEM prototypes will be described in more detail. The procedures for the quality control of the GEM foils, including gain uniformity measurements with an x-ray source will be presented. In the past few years, several CMS triple-GEM prototype detectors were operated with test beams at the CERN SPS. The results of these test beam campaigns will be summarised.

**KEYWORDS:** Particle tracking detectors; Gaseous detectors; Electron multipliers (gas); Particle tracking detectors (Gaseous detectors)

---

## Contents

<b>1</b>	<b>Introduction</b>	<b>1</b>
1.1	Goals of the muon upgrade	1
1.2	GEM technology for CMS	2
1.3	Construction of the triple-GEM prototypes	3
<b>2</b>	<b>Quality control and beam tests of the triple-GEM detectors</b>	<b>3</b>
2.1	Quality control procedures	3
2.2	Beam tests and results	5
<b>3</b>	<b>Summary and conclusion</b>	<b>8</b>

---

## 1 Introduction

The CMS detector installed at the CERN Large Hadron Collider has an extensive muon system [1] which provides information simultaneously for identification, track reconstruction and triggering of muons. It relies on three types of gaseous detectors: Resistive Plate Chambers (RPCs) [2], Cathode Strip Chambers (CSCs) [3] and Drift Tubes (DTs). The DTs and CSCs provide precision tracking functions, and RPCs provide fast trigger with excellent time resolution. Because of the high rate and high integrated charge, the necessity to upgrade the LHC has given rise to the HL-LHC project so that the CMS muon system will be upgraded with exceptional technological challenges. The high- $\eta$  ( $1.6 < |\eta| < 2.4$ ) region in pseudo-rapidity of the endcaps, which will operate at very high rate after the upgrade of the CMS, needs to be handled, so CMS intends to add new technological detectors to ensure a highly performing muon system during the HL-LHC phase. The CMS GEM collaboration offers a solution to use Gas Electron Multiplier (GEM) [4] based detectors which can be instrumented and installed into this region. The proposal is to cover the high-eta region of the muon system with large-area triple-GEM detectors for Phase 2, which have the ability to provide robust and redundant tracking and triggering functions with an excellent spatial resolution and a high particle rate capability, with a close to 100% detection efficiency.

### 1.1 Goals of the muon upgrade

The installation of the triple-GEM detectors into new muon stations at the end-cap region, which is shown in figure 1, will improve muon momentum resolution, help to reduce the global muon trigger rate, assure a high muon reconstruction efficiency, and increase offline muon identification coverage. The performance of the large area triple-GEMs meets the requirements of the CMS experiment with a time resolution better than 5 ns, operating Ar/CO<sub>2</sub>/CF<sub>4</sub> gas mixture with a spatial resolution of the order of 100  $\mu\text{m}$  and rate capability of 10<sup>5</sup> Hz/cm<sup>2</sup>.

The installation of GEMs (labeled as GE1/1), which are proposed for the second LHC Long Shutdown (LS2), would equip the inner endcap stations, while the installation of the more recent GEMs (labeled as GE2/1 and ME0), which are proposed for the LS3 [5], would equip the second endcap stations. This paper presents only the results of a research on the GE1/1.

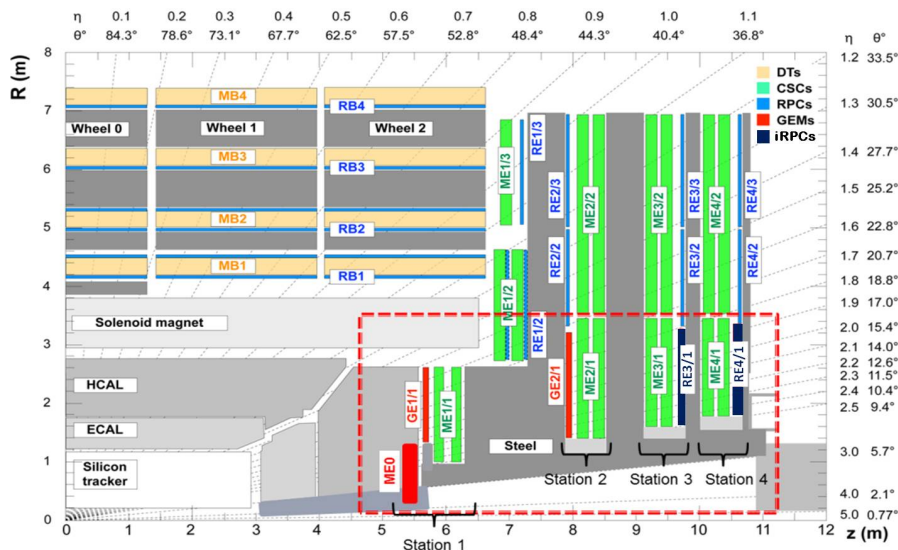

**Figure 1.** A quadrant of the CMS muon system with different subsystems. The stations of the forward detectors are shown in the red box with GE1/1, GE2/1 and ME0.

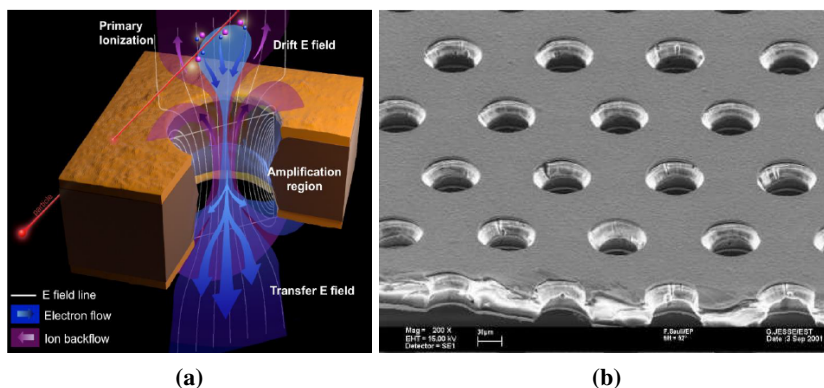

**Figure 2.** Sketch of the working principle (a), GEM electron microscope picture (b).

## 1.2 GEM technology for CMS

The gaseous detectors are based on the principle of ionization produced in the gas by the charged particle. Three layers of GEM foils are used to form triple-GEM detector to produce an electric field as high as  $\sim 80$  kV/cm inside GEM holes. The induced signal on the readout depends mainly on the number of primary electrons released by the charged particles in the induction field. The triple-GEMs have a trapezoidal shaped active area of  $990 \text{ mm} \times (220\text{--}455) \text{ mm}^2$  with a configuration of 3/1/2/1 mm which corresponds to the drift, the first transfer, the second transfer, and induction field, respectively [6]. An avalanche of electrons is created through the holes because of the very high electric field, which is shown in the figure 2(a). GEM consists of a two-side copper-clad Kapton foil, perforated with a high density of holes which are typically  $140 \mu\text{m}$  pitch and  $70 \mu\text{m}$  hole diameter as can be seen in figure 2(b).

### 1.3 Construction of the triple-GEM prototypes

The CMS triple-GEM prototypes are produced with very innovative assembly technique based on mechanical stretching of the GEM foils. Initially, the GEM foils are tested for leakage current and the readout boards are checked with a dedicated tool capable of identifying any possible bending damage. The main steps of the assembly procedure are summarized below and are shown in figure 3.

Step 1: Preparation of the drift board

- The outer frame is fixed to the plexiglass plane using to guiding pins.

Step 2: Preparation of the GEM stack

- The first frame is placed on a rigid support.
- The first GEM foil and the second frame are placed on top.
- The stretching nuts are inserted into the frames.
- The third GEM foil is installed and the last frame closes the stack.

Step 3: Installation and stretching

- The full stack is placed on the drift plane, after removing the guiding pins.
- The stretching screws are fixed by supplying tension to the side screws.
- The high voltage contacts of each GEM foil are checked.
- Stretched GEM foils with inner and outer frames are mounted to the readout board.
- The detector is closed, and the gas in/outlets are inserted in the outer frame.

After these assembly steps, the detector is ready for the Quality Control (QC) checks which are explained in the section 2.

Furthermore, re-opening of the chamber is possible, since glue is not used during the assembly. In addition, a single mask technique is used during the etching of the GEM holes, which is explained in figure 4.

## 2 Quality control and beam tests of the triple-GEM detectors

### 2.1 Quality control procedures

The quality control procedure of GE1/1 detector involves the following steps, respectively.

QC<sub>1</sub>: Cleaning of GEM foils, optical inspection of the drift board, internal and external frames, leakage current test of the readout board, cleaning of all HV parts, screws, gas inlets and outlets.

QC<sub>2</sub>: Assembly of the chamber which is explained in the section 1.3.

QC<sub>3</sub>: Gas leak measurement with dry nitrogen to measure a pressure drop of the order of a few tenths of a millibar per hour.



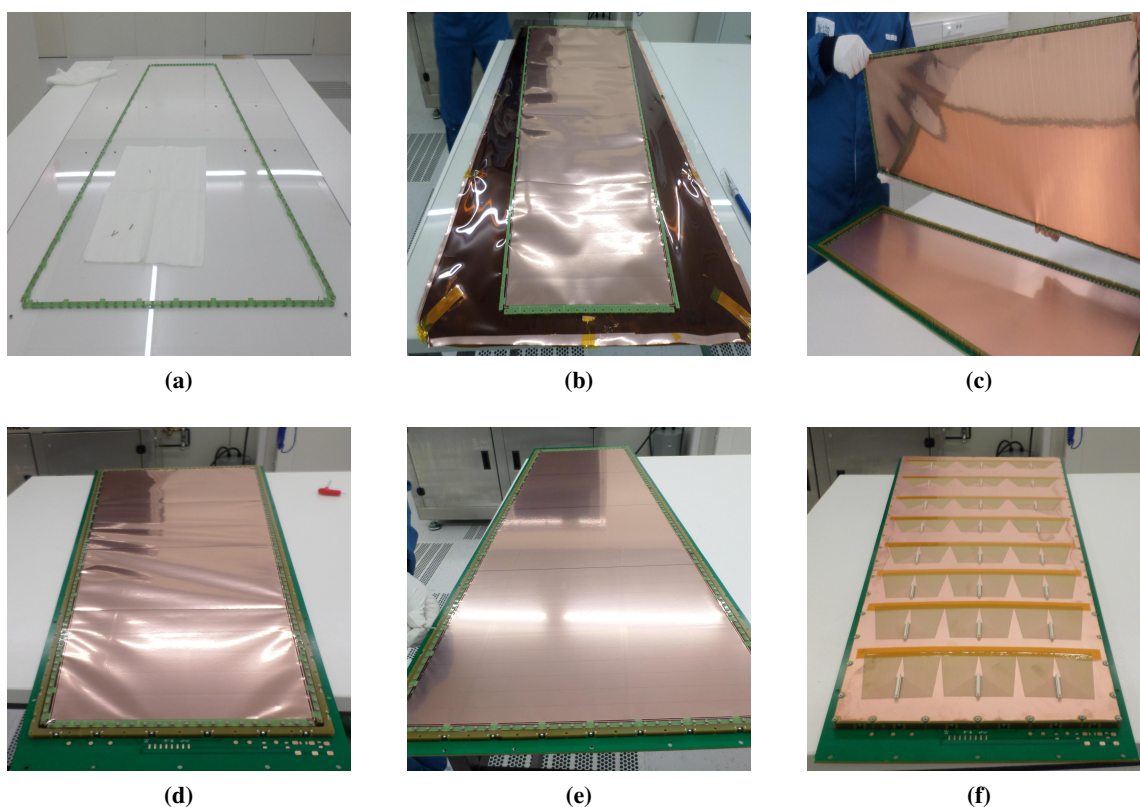

**Figure 3.** Mounting inner frames (a), assembling three GEM foils (b), inserting GEM stack (c), stretching foils with tension (d), stretching foils with frames (e), mounting readout board (f).

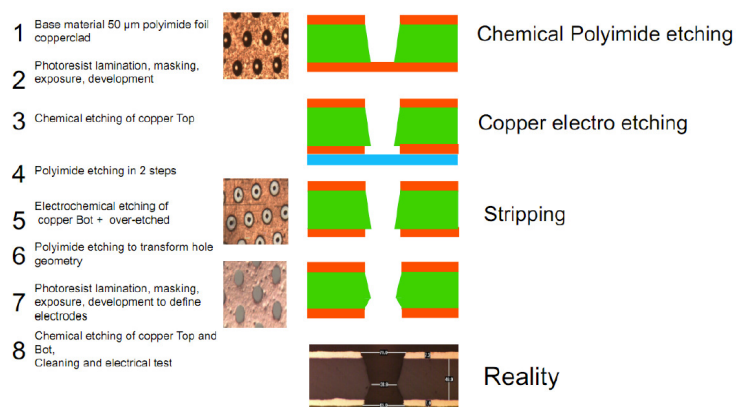

**Figure 4.** Single mask technique during etching of holes.

QC<sub>4</sub>: High voltage test with CO<sub>2</sub> gas by applying 5 kV.

QC<sub>5</sub>: Gain uniformity test of the chamber with a radioactive source.

QC<sub>6</sub>: Gain, efficiency, noise and cluster size measurements with final electronics.

QC<sub>7</sub>: Assembly of the Super Chambers.



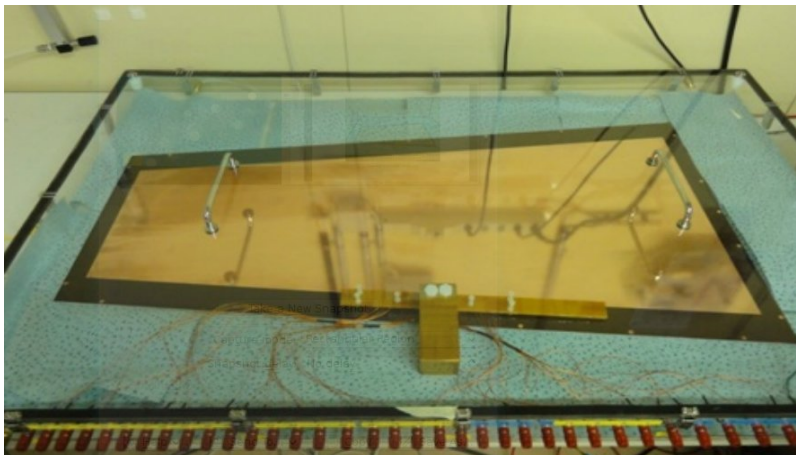

**Figure 5.** GEM-foil leakage current test setup.

QC<sub>8</sub>: High voltage scan of the Super Chambers to measure the gain, efficiency and spatial, resolution, test of the electronics.

QC<sub>9</sub>: High voltage stability test with dry nitrogen for installation in storage rack.

QC<sub>10</sub>: Final gas leak and high voltage test.

Before the assembly of the GEM prototype, GEM foils are placed inside a plexiglass box, which is flushed with pure nitrogen to keep the volume dry as can be seen in figure 5. With an applied potential difference of 600 V between the GEM metal sides, the GEM foil should draw a current no more than 30 nA which corresponds to QC<sub>1</sub>. Otherwise, it shows that the foil does not qualify for the test, and it means that the leakage current occurs.

After the assembly, the chamber is tested for gas leaks with dry and filtered nitrogen by pressuring up to 20 mbar for one hour. Gain calibration and uniformity tests (QC<sub>5</sub>) are performed with an Amptek portable mini x-ray generator with cone size of 120 degrees to irradiate entire chamber simultaneously. The full detector is readout with a Scalable Readout System (SRS), where a signal coming from the bottom side of the lowest GEM foil is used to generate a trigger for the APV25 Hybrids. Data transmission between the APV25 Hybrids and SRS FECs which is shown in figure 6, is supplied by the HDMI cable.

After the uniformity measurements, the chambers are tested on a cosmic stand to determine the efficiency, cluster size, spatial resolution and to check the readout connectivity. Before the assembly of the super-chamber (SC) which is fabricated by coupling together two GE1/1 single chambers, the final electronics are also tested. The functional requirements of the final electronics on the readout system provide both triggering and tracking information. The VFAT2 architecture is the baseline for the new front-end ASIC, the VFAT3, being currently developed for the CMS triple-GEM system [7]. Finally, super chambers are prepared for the installation into the experiment.

## 2.2 Beam tests and results

The performance of the GE1/1 prototypes was evaluated during the test beams that took place at CERN and Fermi Lab in November 2012 and October 2013, respectively. During the test beam at

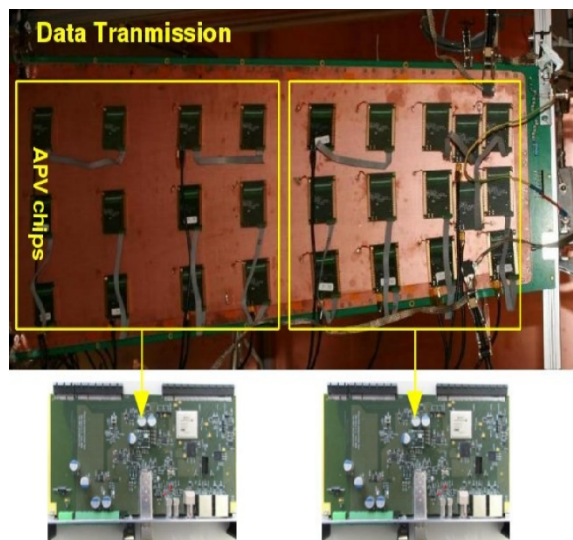

**Figure 6.** Data transmission between the APV25 Hybrids and SRS FECs.

CERN, three standard triple-GEM muon detectors with  $10 \times 10 \text{ cm}^2$  were used as tracking system with pion and muon beam at 150 GeV, flushing with Ar/CO<sub>2</sub> (70:30) gas mixture with a gain around  $10^4$ . The beam energies were mixed hadrons at 32 GeV and proton beam at 120 GeV during the Fermi Lab test beam. Tracking system included two standard  $10 \times 10 \text{ cm}^2$  triple-GEM detectors and one  $50 \times 50 \text{ cm}^2$  triple-GEM detector, flushing with Ar/CO<sub>2</sub> (70:30). The binary VFAT2 [8] chip and the analogue APV25 [9] chip were adopted for the strip readout at CERN and Fermi Lab, respectively. The measured spatial resolution of  $267 \mu\text{m}$  is in agreement with the theoretical value of  $265 \mu\text{m}$  for 0.88 mm pitch using digital VFAT2 readout at CERN [10]. An efficiency of 98% was achieved when the detector operated with high voltage that corresponds to a gain about  $10^4$  during the test beam at CERN. The resolution of the triple-GEM prototype was calculated as  $103 \mu\text{rad}$  (22% of strip pitch) which corresponds to  $193 \mu\text{m}$  in the centre of eta sector 5 (the fifth row with three APVs on the detector readout) by using the pulse-height sensitive analogue readout at Fermi Lab test beam. The detection efficiency was measured as about 97.8% during the test beam at Fermi Lab.

The performance of the final version of the CMS triple-GEMs has also been evaluated in two more recent test beam campaigns during the last October and December 2014 at CERN Super Proton Synchrotron (SPS) [11]. Figure 7 shows the October 2014 test beam set-up where the triple-GEM chambers were operated with Ar/CO<sub>2</sub> (70:30) gas mixture and muon beam. The setup consisted of a GEM tracking system, included three  $10 \times 10 \text{ cm}^2$  triple-GEM detectors equipped with 2D readout strips with a pitch of 0.4 mm, and three GE1/1 detectors displaced horizontally. The GEM tracking system and the GE1/1 detectors were readout using VFAT2 electronics. One of the GE1/1 detectors had been already irradiated for six months in the Gamma Irradiation Facility (GIF), the other one was a GE1/1-IV (this generation is the first large-area GEM detector produced without gluing any components) that was not irradiated, and the final one was a GE1/1-V which was the last generation of the CMS triple-GEMs. The external trigger was provided by the coincidence between the discriminated signals of three scintillators. The main goal for the October 2014 beam test was to perform the tests to compare the efficiencies between these GE1/1 prototypes, and

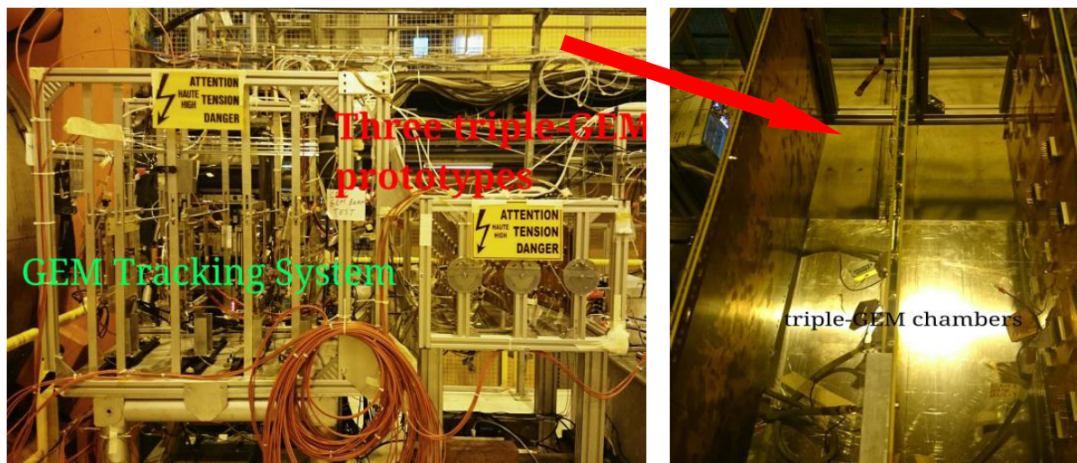

Figure 7. The test beam setup used during the October 2014 campaign.

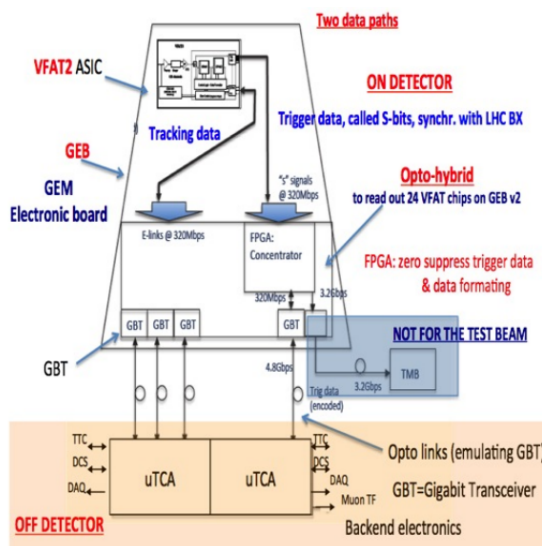

Figure 8. Sketch of the proposed GEM electronics readout system.

also to measure the spatial resolution, the time resolution, the cluster size and the noise levels for all measurements versus the induction and drift field for the October 2014 beam test.

For the December 2014 test beam, one of the purposes was to test and debug the proposed GEM electronics readout system which is shown in the figure 8. There are two main components of the electronics as On Detector and Off Detector. On Detector electronics connect the inputs of the front-end ASIC (VFAT2) to the GEM readout board (GEB). The VFAT2 is connected to the hybrids which are plugged into the connectors on the readout board. The communication to the Off Detector electronics is performed through optical links which is Opto-hybrid plugged into the GEB with FPGA, Gigabit Transceiver (GBT), and the optical connectors [12].

The analysis has already been started for the collected data and the preliminary results will be reported in the coming months.



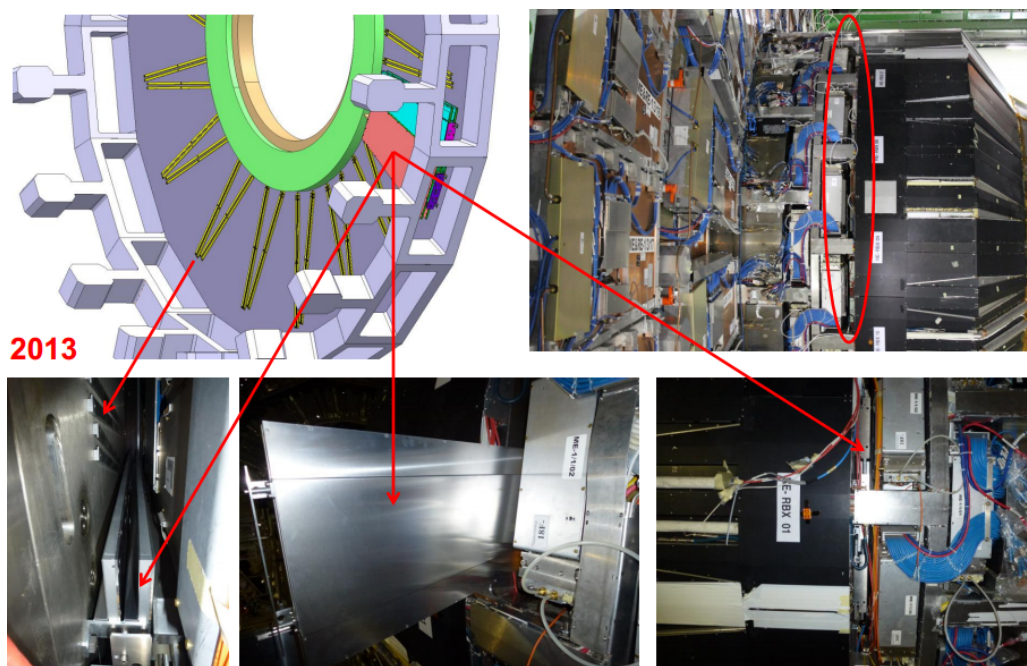

**Figure 9.** Trial installation of the GEM Super chambers in CMS.

### 3 Summary and conclusion

The CMS GEM collaboration has been developing prototypes since 2009 for the CMS Phase 2 Muon System Upgrade. The chamber configuration is now finalized, and the full-size trapezoidal triple-GEM prototypes have been successfully built and tested. Test beam measurements yield acceptable results in terms of detector performance. These successfully tested detectors will be installed in CMS during the LHC 2016 technical stop as the first part of the proposal of the GEM collaboration. Figure 9 shows the installation of a demonstrator system made of GE1/1 super-chambers into the LHC CMS system. The full installation of the GE1/1 system is proposed for the LHC 2018–2019 long shutdown.

### Acknowledgments

The authors would like to acknowledge the technical support from CERN as well as the RD51 collaboration.

### References

- [1] CMS collaboration, *The CMS experiment at the CERN LHC*, 2008 *JINST* **3** S08004.
- [2] R. Santonico and R. Cardarelli, *Development of resistive plate counters*, *Nucl. Instrum. Meth.* **187** (1981) 377.
- [3] CMS collaboration, *Cathode strip chambers for the CMS endcap muon system*, *Nucl. Instrum. Meth.* **A 384** (1996) 207.
- [4] F. Sauli, *GEM: A new concept for electron amplification in gas detectors*, *Nucl. Instrum. Meth.* **A 386** (1997) 531.

- [5] CMS collaboration, *CMS The Muon Project Technical Design Report*, CERN-LHCC-1008-032, CMS-TDR-3.
- [6] D. Abbaneo et al., *Test beam results of the GE1/1 prototype for a future upgrade of the CMS high- $\eta$  muon system*, *IEEE Nucl. Sci. Symp. Conf. Rec.* (2011) 1806 [[arXiv:1111.4883](#)].
- [7] D. Abbaneo et al., *Development of the data acquisition system for the Triple-GEM detectors for the upgrade of the CMS forward muon spectrometer*, *2014 JINST* **9** C03052.
- [8] P. Aspell et al., *The VFAT production test platform for the TOTEM experiment*, in proceedings of *Topical Workshop on Electronics for Particle Physics 2008*, Naxos, Greece, 15–19 September 2008, CERN-2008-008.
- [9] S. Martoiu et al., *Front-end electronics for the Scalable Readout System of RD51*, in proceedings of *IEEE Nuclear Science Symposium and Medical Imaging Conference (NSS/MIC)*, Valencia, Spain, 23–29 October 2011, pg. 2036.
- [10] D. Abbaneo et al., *Development and performance of large scale triple GEM for CMS*, *2013 JINST* **8** C11017.
- [11] D. Abbaneo, S. Bally, H. Postema, A. Conde Garcia, J.P. Chatelain et al., *Characterization of GEM Detectors for Application in the CMS Muon Detection System*, *IEEE Nucl. Sci. Symp. Conf. Rec.* (2010) 1416 [[arXiv:1012.3675](#)].
- [12] P. Vichoudis et al., *The Gigabit Link Interface Board (GLIB), a flexible system for the evaluation and use of GBT-based optical links*, *2010 JINST* **5** C11007.