

VCID/US 202/13

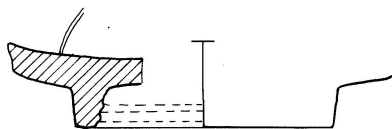

VCID/US 216/2



VCSC 95/US 62/13

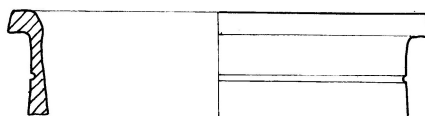

VCSC 95/US 91/21



VCID/US 202/45

(scala 1:3)



VCSC 95/US 104/42



VCSC 95/US 104/95

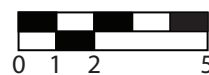

DSCP/US 201/12

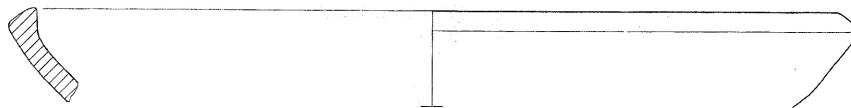

VCSC 95/US 91/41



2672/US 330/2  
(scala 1:3)



2672/US 112/2

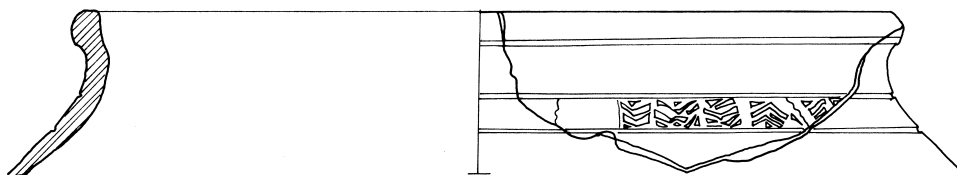

2672/US 320/4

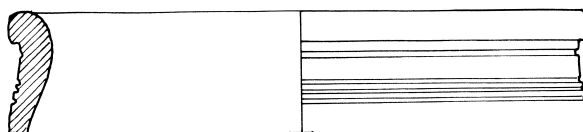

2672/US FS2/4

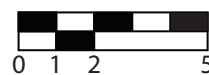
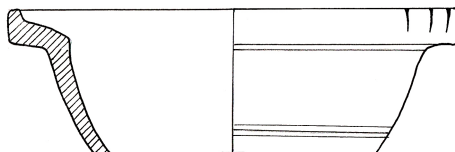

2672/US 286/19

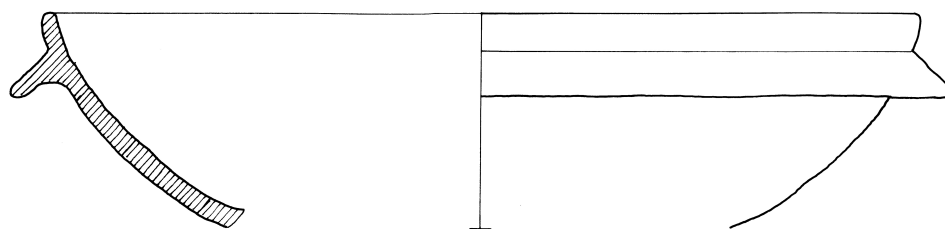

2672/US 286/20

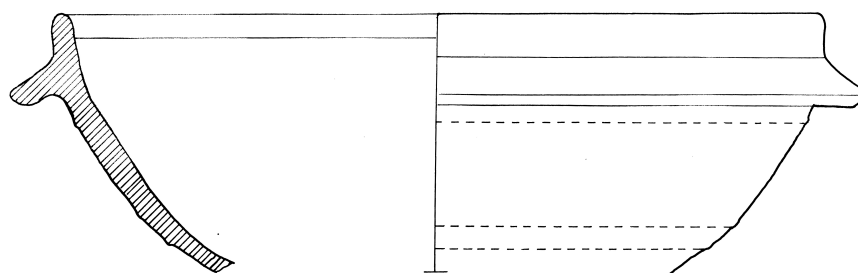

2672/US 275/2

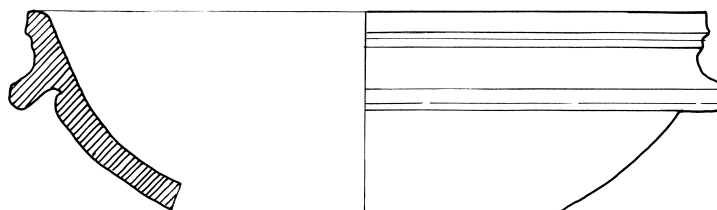

ASI/US 81/1

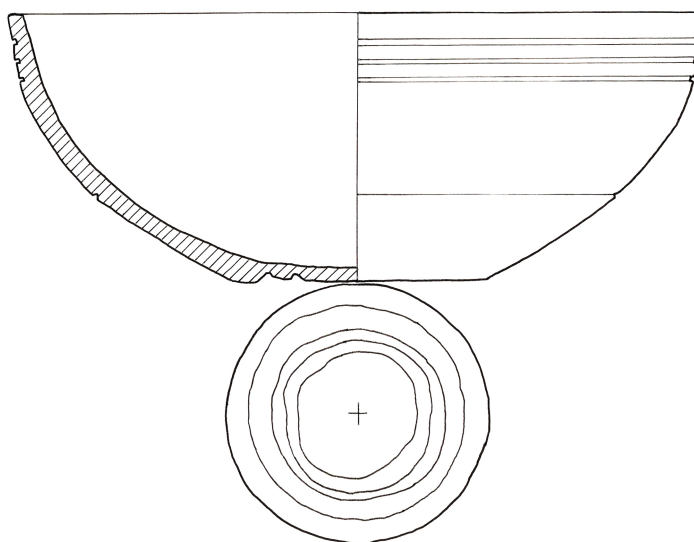

2672/US 133/5

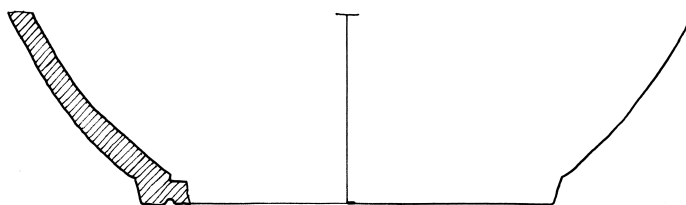

2672/US 106/9 e 5

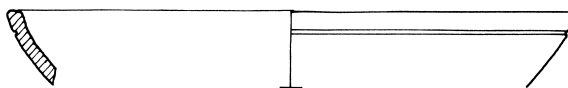

2672/US 121/5

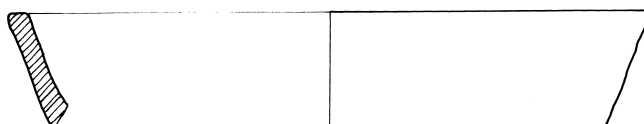

VCSC 95/US 104/13

